



Main

Range compatibility	Lexium 28
Product or component type	Servo motor
Device short name	BCH2

Complementary

Maximum mechanical speed	3000 rpm
[Us] rated supply voltage	220 V
Phase	Three phase Single phase
Continuous stall current	2.89 A
Continuous stall torque	21.15 Lbf.In (2.39 N.m) LXM28... 4.5 A, 220 V, single phase 21.15 Lbf.In (2.39 N.m) LXM28... 4.5 A, 220 V, three phase 21.15 lbf.in (2.39 N.m) LXM28... 9 A, 110 V, single phase
Continuous power	500 W
Peak stall torque	63.37 Lbf.In (7.16 N.m) LXM28... 4.5 A, 220 V, single phase 63.37 Lbf.In (7.16 N.m) LXM28... 4.5 A, 220 V, three phase 63.37 lbf.in (7.16 N.m) LXM28... 9 A, 110 V, single phase
Nominal output power	500 W LXM28... 4.5 A, 220 V, single phase 500 W LXM28... 4.5 A, 220 V, three phase 500 W LXM28... 9 A, 110 V, single phase
Nominal torque	21.15 Lbf.In (2.39 N.m) LXM28... 4.5 A, 220 V, single phase 21.15 Lbf.In (2.39 N.m) LXM28... 4.5 A, 220 V, three phase 21.15 lbf.in (2.39 N.m) LXM28... 9 A, 110 V, single phase
Nominal speed	2000 rpm LXM28... 4.5 A, 220 V, single phase 2000 rpm LXM28... 4.5 A, 220 V, three phase 2000 rpm LXM28... 9 A, 110 V, single phase
Maximum current Irms	9.18 A LXM28... 0.5 kW, 220 V 9.18 A LXM28... 0.5 kW, 110 V
Maximum permanent current	3.24 A
Product compatibility	LXM28... servo drive 0.5 kW, 220 V, single phase LXM28... servo drive 0.5 kW, 220 V, three phase LXM28... servo drive 0.5 kW, 110 V, single phase
Shaft end	Smooth shaft
Shaft diameter	0.87 in (22 mm)
Shaft length	1.77 in (45 mm)
Feedback type	20 bits single turn absolute encoder
Holding brake	Without
Mounting support	Asian standard flange
Motor flange size	5.12 in (130 mm)
Electrical connection	Connector MIL
Torque constant	0.83 N.m/A 68 °F (20 °C)
Back emf constant	50 V/krpm 68 °F (20 °C)
Rotor inertia	6.63 kg.cm ²
Stator resistance	0.62 Ohm 68 °F (20 °C)

Stator inductance	7.4 mH 68 °F (20 °C)
Stator electrical time constant	11.94 ms 68 °F (20 °C)
Maximum radial force Fr	670 N 2000 rpm
Maximum axial force Fa	200 N
Brake pull-in power	19.7 W
Type of cooling	Natural convection
Length	5.79 in (147 mm)
Number of motor stacks	1
Centring collar diameter	4.33 in (110 mm)
Centring collar depth	0.31 in (8 mm)
Number of mounting holes	4
Mounting holes diameter	0.36 in (9.2 mm)
Circle diameter of the mounting holes	5.71 in (145 mm)
Distance shaft shoulder-flange	0.31 in (8 mm)
Net Weight	15.43 lb(US) (7 kg)

Environment

IP degree of protection	IP50 IM V3 IP65 IM B5, IM V1
Ambient air temperature for operation	-4...104 °F (-20...40 °C)

Ordering and shipping details

Category	18281 - LEXIUM 23/28 MOTORS
Discount Schedule	PC53
GTIN	03606480734168
Nbr. of units in pkg.	1
Package weight(Lbs)	17.4 lb(US) (7.89 kg)
Returnability	No
Country of origin	CN

Packing Units

Unit Type of Package 1	PCE
Package 1 Height	7.13 in (18.1 cm)
Package 1 width	9.06 in (23 cm)
Package 1 Length	14.17 in (36 cm)

Dimensions

Dimensions of Motor

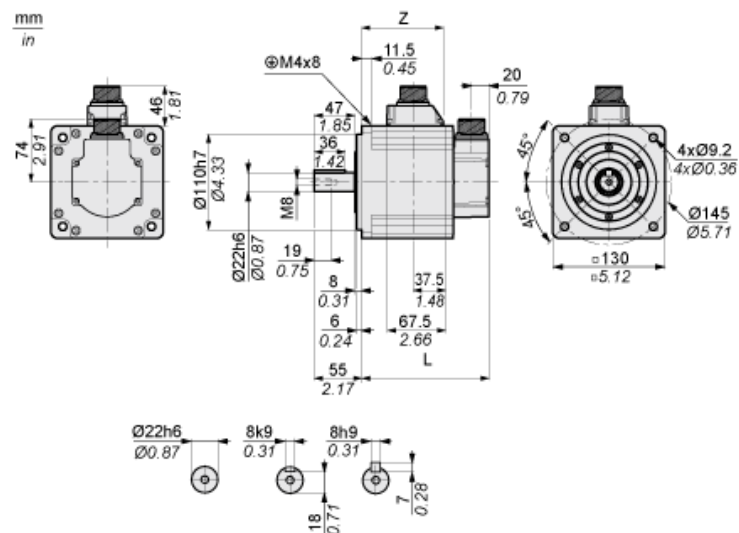

	mm	in.
L (without holding brake)	147	5.79
L (with holding brake)	183	7.2
Z	94.5	3.72

Torque/Speed Curves with 230 V Single/Three Phase Supply Voltage

Servo Motor with LXM28AU04●●● Servo Drive

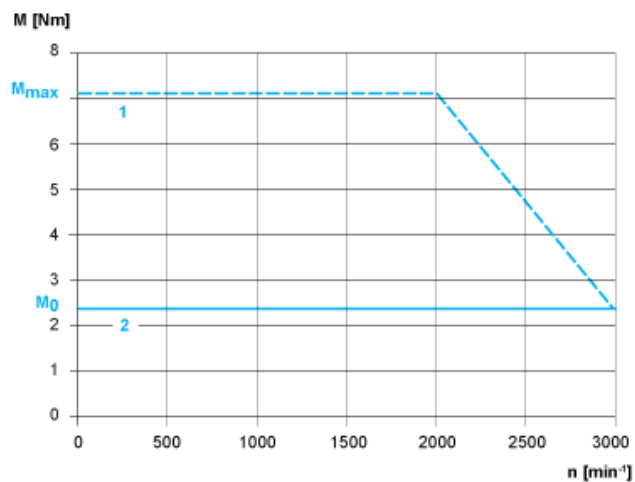

- 1 : Peak torque
- 2 : Continuous torque