



# MARCUS

Marcus Transformer LTD  
 Phone: 1-800-267-7376  
 Fax: 1-866-205-7526  
 Email: Info@marcustransformer.com

## TECHNICAL DATA

SINGLE PHASE CONTROL TRANSFORMER

### DESCRIPTION

MODEL	MO100N
Type	Open
VA	100
Primary (Volts)	120
Secondary (Volts)	24
Input /Output Amps	0.83 / 4.17
Temperature Rise	80°C
Insulation Class	B (130°C)
Frequency	60Hz
Polarity	additive
Noise level	less than 40DB
Winding	Copper
Approvals	CE compliant UL listed CSA approved

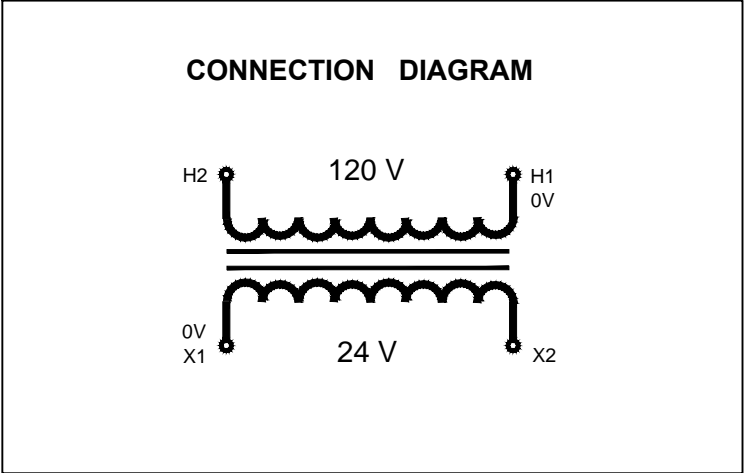

### WIRING CONNECTION

PRIMARY :	
VOLTS 120	CONNECT LINES TO : H1-H2
SECONDARY :	
VOLTS 24	CONNECT LINES TO : X1-X2

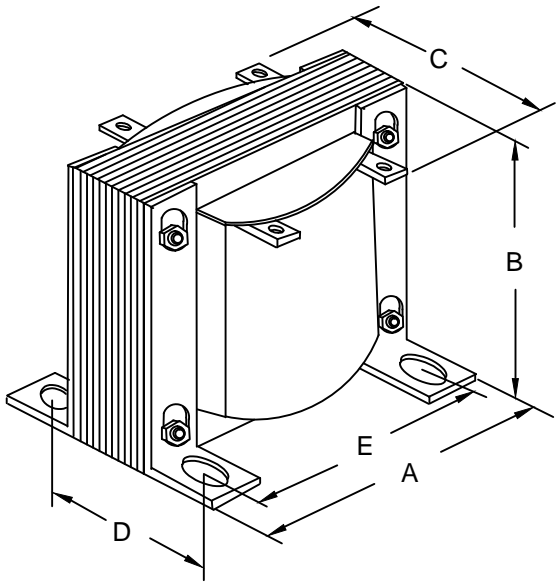

### DIMENSIONS INCHES / MM

VA	A	B	C	D	E	MOUNTING HOLES INCHES / MM	SHIP WEIGHT LBS / KG
100	3.00 76.2	2.50 63.5	3.27 83.1	2.50 63.5	2.50 63.5	0.21 x 0.625 5.3 x 15.9	2.75 1.3

Notes: