

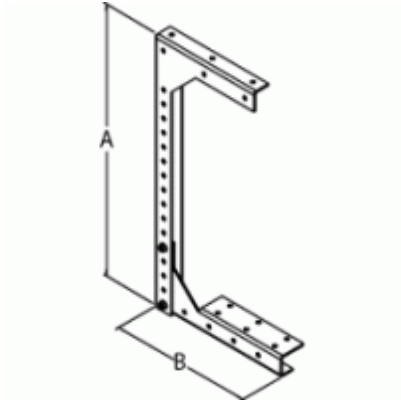

Quality Products. Service Excellence.

Bracket Hanger Ceiling Type *CWH Series*



Part No.	For use with	H (max.)	W
CWHD2	2.5 x 2.5	12.00	6.62
CWHD4	4 x 4	15.00	8.12
CWHD6	6 x 6	19.00	10.12
CWHD8	8 x 8	23.00	12.12
CWHD10	10 x 10	27.00	14.12
CWHD12	12 x 12	31.00	16.12



Data subject to change without notice

© 2022. Hammond Manufacturing Ltd. All rights reserved.