

GV2P02

TeSys Deca Manual Starter and Protector, thermal magnetic circuit protector, rotary handle, 0.16...0.25 A, screw clamp terminals



Main

Range	TeSys Deca
Product name	TeSys GV2 TeSys Deca
Product or Component Type	Motor circuit breaker
Device short name	GV2P
Device Application	Motor protection
Trip unit technology	Thermal-magnetic

Complementary

Poles description	3P
Network type	AC
Utilisation category	Category A IEC 60947-2 AC-3 IEC 60947-4-1 AC-3e IEC 60947-4-1
Network frequency	50/60 Hz IEC 60947-4-1
Fixing mode	35 mm symmetrical DIN rail clipped Panel screwed with 2 x M4 screws)
Motor power kW	0.06 kW 400/415 V AC 50/60 Hz
Breaking capacity	100 KA Icu 230/240 V AC 50/60 Hz IEC 60947-2 100 KA Icu 400/415 V AC 50/60 Hz IEC 60947-2 100 KA Icu 440 V AC 50/60 Hz IEC 60947-2 100 KA Icu 500 V AC 50/60 Hz IEC 60947-2 100 kA Icu 690 V AC 50/60 Hz IEC 60947-2
[Ics] rated service short-circuit breaking capacity	100 % 230/240 V AC 50/60 Hz IEC 60947-2 100 % 400/415 V AC 50/60 Hz IEC 60947-2 100 % 440 V AC 50/60 Hz IEC 60947-2 100 % 500 V AC 50/60 Hz IEC 60947-2 100 % 690 V AC 50/60 Hz IEC 60947-2
Control type	Rotary handle
Line Rated Current	0.25 A
Thermal protection adjustment range	0.16...0.25 A IEC 60947-4-1
Magnetic tripping current	2.4 A
[Ith] conventional free air thermal current	0.25 A IEC 60947-4-1
[Ue] rated operational voltage	690 V AC 50/60 Hz IEC 60947-2
[Ui] rated insulation voltage	690 V AC 50/60 Hz IEC 60947-2
[Uimp] rated impulse withstand voltage	6 kV IEC 60947-2
Phase failure sensitivity	Yes IEC 60947-4-1
Suitability for isolation	Yes IEC 60947-1 § 7-1-6
Power dissipation per pole	2.5 W
Mechanical durability	100000 cycles
Electrical durability	100000 Cycles AC-3 415 V In 100000 cycles AC-3e 415 V In
Rated duty	Continuous IEC 60947-4-1
Tightening torque	15.05 lbf.in (1.7 N.m) screw clamp terminal
Width	1.77 in (45 mm)
Height	3.50 in (89 mm)

The information provided in this documentation contains general descriptions and/or technical characteristics of the performance of the products contained herein. This documentation is not intended as a substitute for and is not to be used for determining suitability or reliability of these products for specific user applications. It is the duty of any such user or integrator to perform the appropriate and complete risk analysis, evaluation and testing of the products with respect to the relevant specific application or use thereof. Neither Schneider Electric Industries SAS nor any of its affiliates or subsidiaries shall be responsible or liable for misuse of the information contained herein.

Depth	3.82 in (97 mm)
Color	Dark grey

Environment

Standards	EN/IEC 60947-2 EN/IEC 60947-4-1
Product Certifications	CCC[RETURN]JUL[RETURN]CSA[RETURN]EAC[RETURN]ATEX[RETURN]LROS (Lloyds register of shipping)[RETURN]BV[RETURN]RINA[RETURN]DNV- GL[RETURN]UKCA
IK degree of protection	IK04
IP degree of protection	IP20 IEC 60529
Climatic withstand	IACS E10
Ambient Air Temperature for Storage	-40...176 °F (-40...80 °C)
Fire resistance	1760 °F (960 °C) IEC 60695-2-11
Ambient air temperature for operation	-4...140 °F (-20...60 °C)
Mechanical robustness	Shocks 30 Gn for 11 ms Vibrations 5 Gn, 5...150 Hz
Operating altitude	6561.68 ft (2000 m)

Ordering and shipping details

Category	22367-MANUAL STR PROTECTOR - GV2
Discount Schedule	I11
GTIN	3389110213416
Returnability	No
Country of origin	FR

Packing Units

Unit Type of Package 1	PCE
Number of Units in Package 1	1
Package 1 Height	1.85 in (4.700 cm)
Package 1 Width	3.66 in (9.300 cm)
Package 1 Length	3.94 in (10.000 cm)
Package 1 Weight	9.24 oz (262.000 g)
Unit Type of Package 2	S02
Number of Units in Package 2	20
Package 2 Height	5.91 in (15.000 cm)
Package 2 Width	11.81 in (30.000 cm)
Package 2 Length	15.75 in (40.000 cm)
Package 2 Weight	12.28 lb(US) (5.570 kg)

Offer Sustainability

California proposition 65	WARNING: This product can expose you to chemicals including: Antimony oxide & Antimony trioxide, which is known to the State of California to cause cancer. For more information go to www.P65Warnings.ca.gov
REACH Regulation	REACH Declaration
EU RoHS Directive	Compliant with Exemptions
China RoHS Regulation	China RoHS Declaration
Environmental Disclosure	Product Environmental Profile
Circularity Profile	End Of Life Information
WEEE	The product must be disposed on European Union markets following specific waste collection and never end up in rubbish bins.

Contractual warranty

Warranty	18 months
----------	-----------

Thermal-Magnetic Tripping Curves for GV2ME and GV2P

Average Operating Times at 20 °C Related to Multiples of the Setting Current

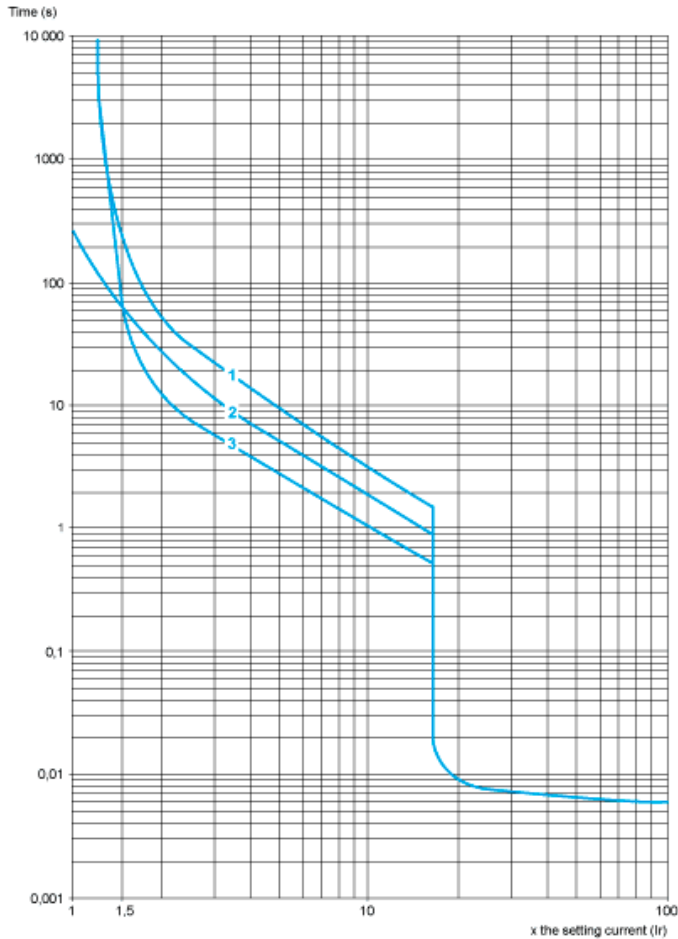

- 1 3 poles from cold state
- 2 2 poles from cold state
- 3 3 poles from hot state

Current Limitation on Short-Circuit for GV2ME and GV2P (3-Phase 400/415 V)

Dynamic Stress

$I_{peak} = f(\text{prospective } I_{sc}) \text{ at } 1.05 U_e = 435 \text{ V}$

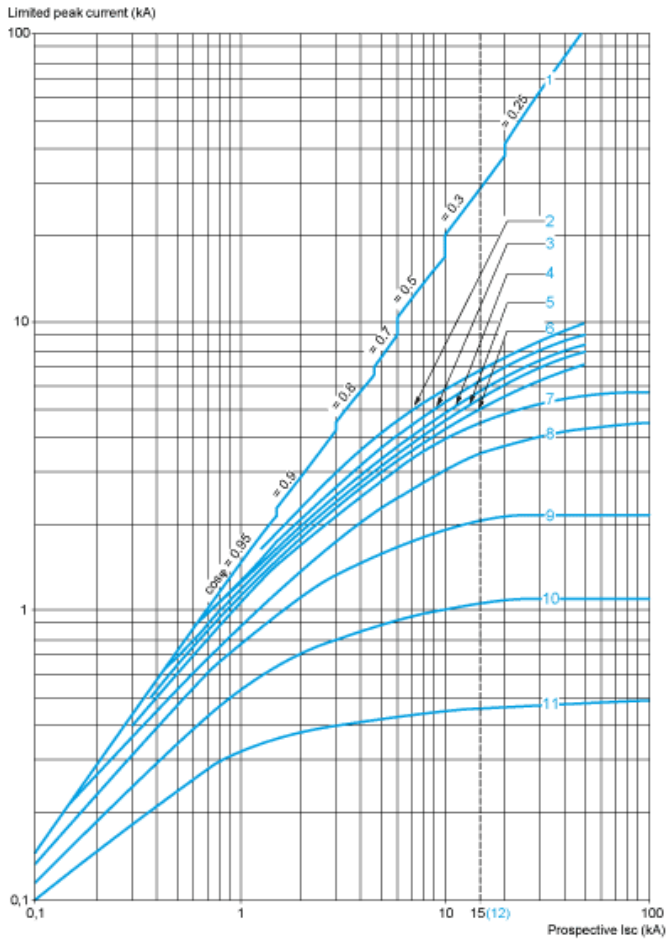

- 1 Maximum peak current
- 2 24-32 A
- 3 20-25 A
- 4 17-23 A
- 5 13-18 A
- 6 9-14 A
- 7 6-10 A
- 8 4-6.3 A
- 9 2.5-4 A
- 10 1.6-2.5 A
- 11 1-1.6 A
- 12 Limit of rated ultimate breaking capacity on short-circuit of GV2ME (14, 18, 23, and 25 A ratings).

Thermal Limit on Short-Circuit for GV2P

Thermal Limit in kA^2s in the Magnetic Operating Zone

Sum of $I^2dt = f$ (prospective Isc) at $1.05 U_e = 435 V$

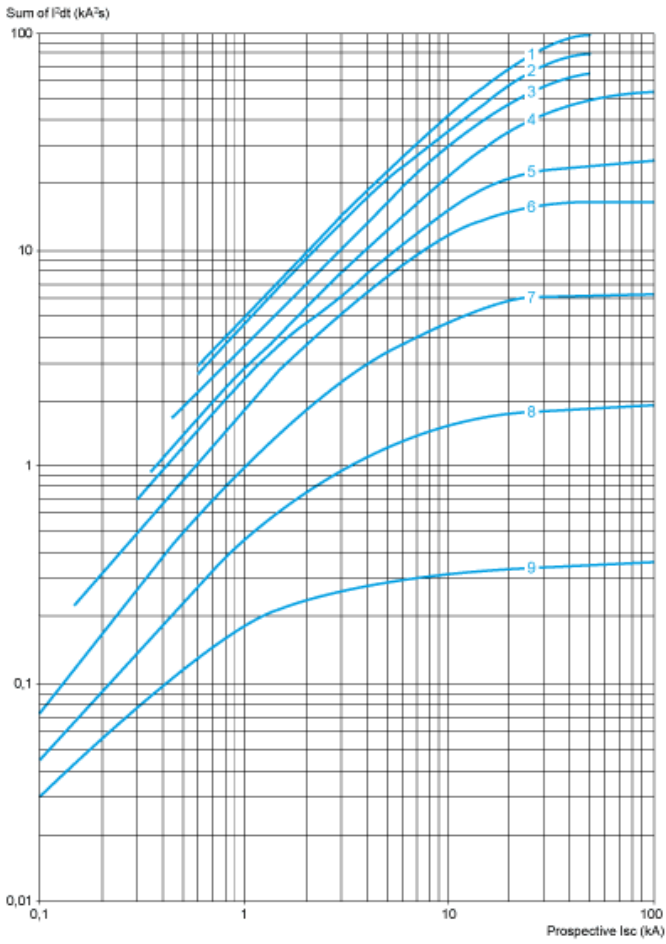

- 1 24-32 A
- 2 20-25 A
- 3 17-23 A
- 4 13-18 A
- 5 9-14 A
- 6 6-10 A
- 7 4-6.3 A
- 8 2.5-4 A
- 9 1.6-2.5 A
- 10 1-1.6 A

GV2P

On rail AM1 DE200, ED200 (35 x 15)

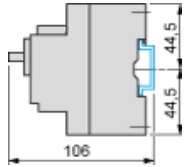

Panel mounted

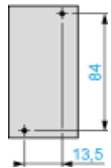

On pre-slotted plate AM1 PA

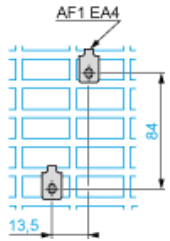

Adapter plate GK2AF01

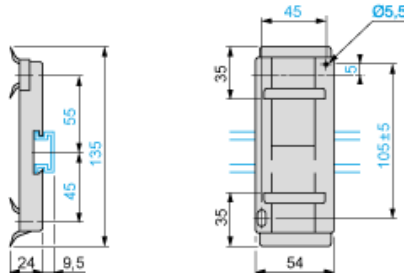

Combination GV2P + TeSys d contactor

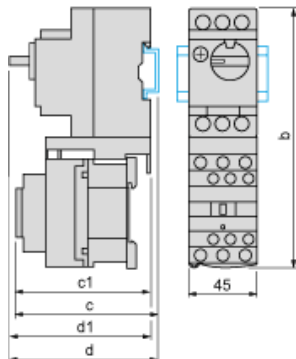

GV2P +	LC1D09...D18	LC1D25 and D32
b	176.4	186.8
c1	100.1	106.4
c	105.6	111.9
d1	95	95
d	100.5	100.5

Mounting

Mounting of External Operator GV2APN01, GV2APN02 or GV2APN04 for Motor Circuit Breakers GV2P

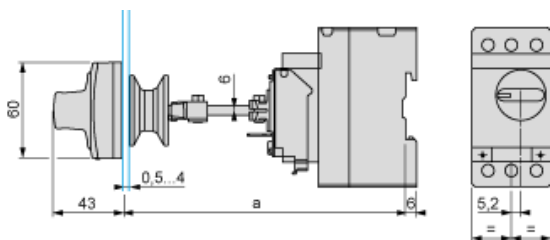

Door cut-out

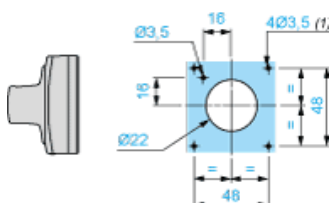

(1) For IP65 only.

Mounting of External Operator GVAPH02 for Motor Circuit Breakers GV2P

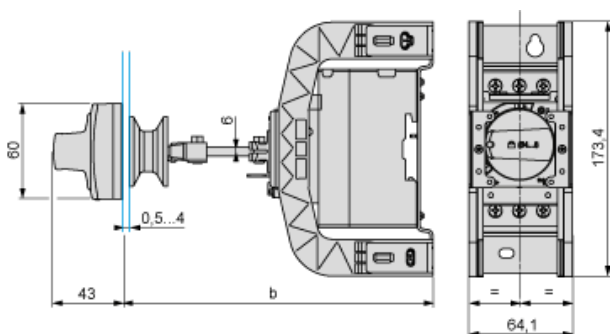

	a		b	
	Minimum	Maximum	Minimum	Maximum
GV2APN..	140	250	–	–
GV2APN.. + GVAPH02	–	–	151	250
GV2APN.. + GVAPK11	250	434	–	–
GV2APN.. + GVAPH02 + GVAPK11	–	–	250	445

Door cut-out

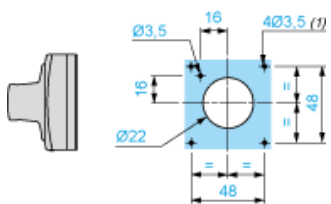

(1) For IP65 only.

GV2P••

