

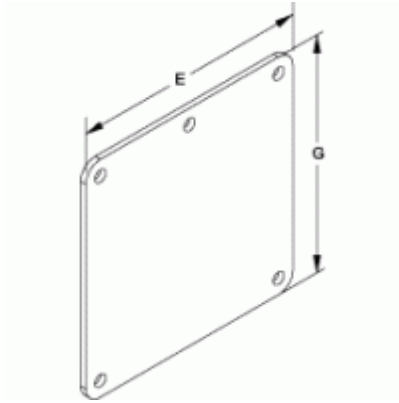

Quality Products. Service Excellence.

Cover Plate 1487HSS Series



Construction

- Covers are formed from 10 gauge Type 304 stainless steel.
- Solid oil resistant gasket and hardware included with each cover plate.

Part No.	For use with	H	W
1487CHSS	4 x 4	5.37	5.37
1487DHSS	6 x 6	7.62	7.62
1487EHSS	8 x 8	9.62	9.62



Data subject to change without notice

© 2022. Hammond Manufacturing Ltd. All rights reserved.