



Quality Products. Service Excellence.

# Heavy Duty Wall Joint *HDSSWJ Series*



- 4G-s.g. cast iron.
- Integrated movement stop.
- One piece bellow.
- Two sleeves.
- Features a rotation range of 170°.

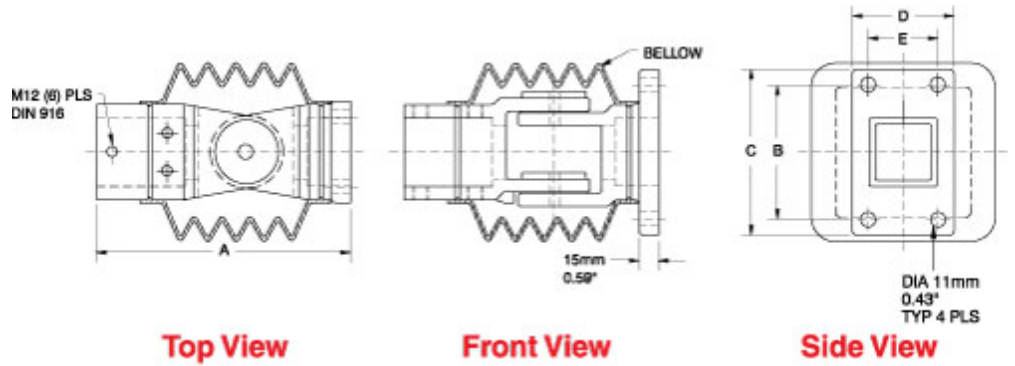

Part No.	System	A	B	C	D	E
R147-010-000R	50	200	105	130	80	55
R147-010-200R	80	275	150	175	115	90

Data subject to change without notice

© 2022. Hammond Manufacturing Ltd. All rights reserved.