



Photoelectric sensors
W24-2, Photoelectric proximity sensor,
Background suppression

WT24-2R220



Type > [WT24-2R220](#)
Part No. > [1016854](#)



Illustration may differ

At a glance

- Precise background suppression at ranges up to 2500 mm
- Immune to ambient light and crosstalk from another photoelectric sensor
- Switch selectable PNP or NPN output, Switch selectable Light or Dark operating mode
- Variants with DC voltage and universal AC/DC voltage with UL approval
- Optional test input, adjustable ON and OFF time delays, alarm output and front screen heating also available in high-power version
- M12 or terminal chamber connection: 90° rotatable
- Red light or long-range IR

Your benefits

- Metal housing that has been IP 69K tested provides reliability and a long service life
- Immune to ambient light and crosstalk, reducing sensor downtime
- Precise detection at long sensing ranges
- User interface is stored under a durable protection hood to prevent unwanted tampering and protect vital components
- Selectable output type, operating mode, and adjustable time delays makes integration easier and reduce the number of devices needed
- Variants with DC voltage and universal AC/DC voltage provide installation flexibility

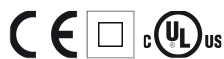

Features

Sensor/detection principle:	Photoelectric proximity sensor, Background suppression
Dimensions (W x H x D):	27 mm x 87.5 mm x 65 mm
Housing design (light emission):	Rectangular
Sensing range max.:	100 mm ... 2,500 mm ¹⁾
Sensing range:	100 mm ... 2,500 mm ²⁾
Type of light:	Infrared light
Light source:	LED ³⁾
Time type:	On delay off delay
Delay time:	Adjustable via time delay selector switch: 0.5 ... 10 s
Alarm output:	-
Adjustment:	Potentiometer
Light spot size (distance):	Ø 80 mm (2,500 mm)

1) 2) Object with 90 % reflectance (referred to standard white, DIN 5033) 3) Average service life of 100,000 h at $T_A = +25\text{ °C}$

Mechanics/electronics

Supply voltage::	12 V DC ... 240 V DC 24 V AC ... 240 V AC ^{1) 2)}
Power consumption:	< 3 VA
Output type:	Relay, electrically isolated ³⁾
Output function:	Change-over contacts
Switching mode:	Light/dark switching ⁴⁾
Switching mode selector:	Selectable via light/dark selector
Switching current (switching voltage):	4 A (24 V DC), 4 A (250 V AC)
Response time:	≤ 10 ms
Switching frequency:	10 Hz ⁵⁾
Connection type:	Terminal connection with M16 gland ⁶⁾
Circuit protection::	A, C ^{7) 8)}
Protection class:	II ⁹⁾
Weight:	330 g
Front screen heating:	✓
Housing material:	Metal, Zinc diecast
Optics material:	PMMA
Enclosure rating:	IP 69K
Usage category:	AC-15, DC-13, According to EN 60947-1
Ambient operating temperature:	-40 °C ... +60 °C
Ambient storage temperature:	-40 °C ... +75 °C

¹⁾ Limit values, operation in short-circuit protected network max. 8 A ²⁾ +/- 10 % ^{3) 4)} Provide suitable spark suppression for inductive or capacitive loads ⁵⁾ With light/dark ratio 1:1 ⁶⁾ Connection rotatable by 90° ⁷⁾ A = V_S connections reverse-polarity protected ⁸⁾ C = interference suppression ⁹⁾ Rated voltage: 250 V AC/DC

Dimensional drawing

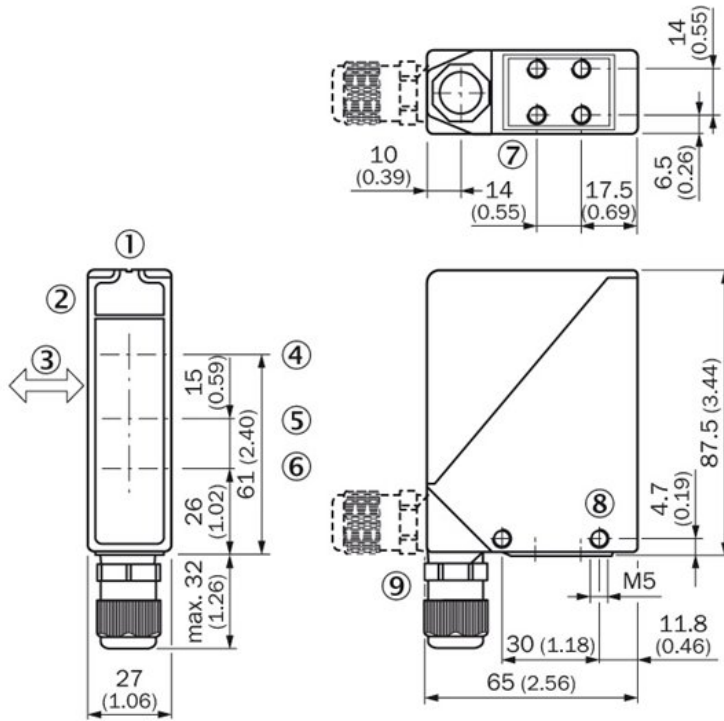

- |1| Alignment sight
- |2| LED signal strength indicator
- |3| Standard direction of the material being detected
- |4| Center of optical axis, sender
- |5| Center of optical axis, receiver (close range)
- |6| Center of optical axis, receiver (far range)
- |7| M5 threaded mounting hole, 6 mm deep
- |8| M5 threaded mounting hole, through-hole
- |9| M16 screw fixing and plug rotatable by 90°

Adjustments possible

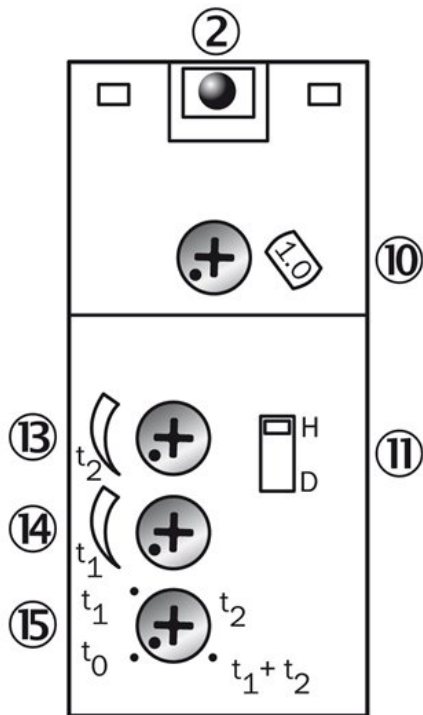

- |2| LED signal strength indicator
- |10| Adjustment sensing range (WT) / sensitivity (WL, WS/WE)
- |11| Light/dark selector
- |12| Time control t2=OFF-delay
- |13| Time control t1=ON-delay
- |14| time delay selector switch

Connection diagram

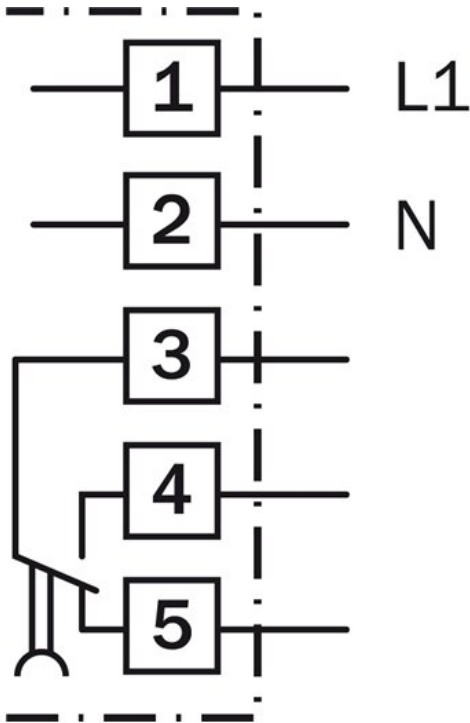

Characteristic curve

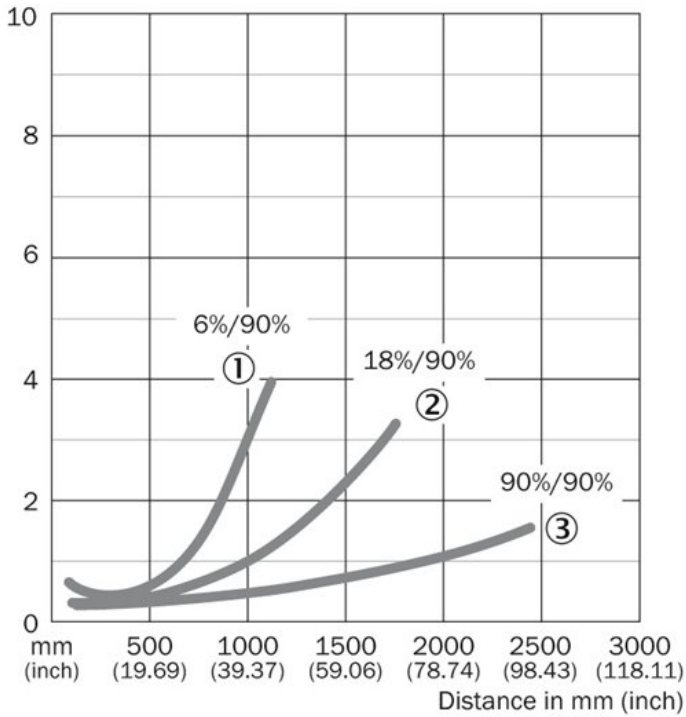

- [1] Sensing range on black, 6 % remission
- [2] Sensing range on gray, 18 % remission
- [3] Sensing range on white, 90 % remission

Connection type

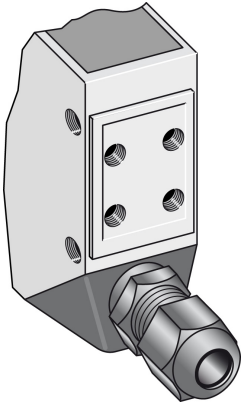

Sensing range diagram

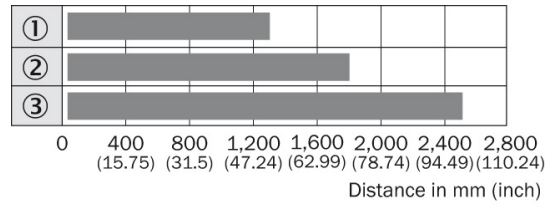

■ Operating distance

- ① Scanning distance on black, 6 % remission
- ② Scanning distance on grey, 18 % remission
- ③ Scanning distance on white, 90 % remission

Australia

Phone +61 3 9457 0600
1800 33 48 02 – tollfree
E-Mail sales@sick.com.au

Belgium/Luxembourg

Phone +32 (0)2 466 55 66
E-Mail info@sick.be

Brasil

Phone +55 11 3215-4900
E-Mail marketing@sick.com.br

Canada

Phone +1 905 771 14 44
E-Mail information@sick.com

Česká republika

Phone +420 2 57 91 18 50
E-Mail sick@sick.cz

China

Phone +86 4000 121 000
E-Mail info.china@sick.net.cn
Phone +852-2153 6300
E-Mail ghk@sick.com.hk

Danmark

Phone +45 45 82 64 00
E-Mail sick@sick.dk

Deutschland

Phone +49 211 5301-301
E-Mail info@sick.de

España

Phone +34 93 480 31 00
E-Mail info@sick.es

France

Phone +33 1 64 62 35 00
E-Mail info@sick.fr

Great Britain

Phone +44 (0)1727 831121
E-Mail info@sick.co.uk

India

Phone +91-22-4033 8333
E-Mail info@sick-india.com

Israel

Phone +972-4-6881000
E-Mail info@sick-sensors.com

Italia

Phone +39 02 27 43 41
E-Mail info@sick.it

Japan

Phone +81 (0)3 5309 2112
E-Mail support@sick.jp

Magyarország

Phone +36 1 371 2680
E-Mail office@sick.hu

Nederland

Phone +31 (0)30 229 25 44
E-Mail info@sick.nl

Norge

Phone +47 67 81 50 00
E-Mail sick@sick.no

Österreich

Phone +43 (0)22 36 62 28 8-0
E-Mail office@sick.at

Polska

Phone +48 22 837 40 50
E-Mail info@sick.pl

România

Phone +40 356 171 120
E-Mail office@sick.ro

Russia

Phone +7-495-775-05-30
E-Mail info@sick.ru

Schweiz

Phone +41 41 619 29 39
E-Mail contact@sick.ch

Singapore

Phone +65 6744 3732
E-Mail sales.gsg@sick.com

Slovenija

Phone +386 (0)1-47 69 990
E-Mail office@sick.si

South Africa

Phone +27 11 472 3733
E-Mail info@sickautomation.co.za

South Korea

Phone +82 2 786 6321/4
E-Mail info@sickkorea.net

Suomi

Phone +358-9-25 15 800
E-Mail sick@sick.fi

Sverige

Phone +46 10 110 10 00
E-Mail info@sick.se

Taiwan

Phone +886 2 2375-6288
E-Mail sales@sick.com.tw

Türkiye

Phone +90 (216) 528 50 00
E-Mail info@sick.com.tr

United Arab Emirates

Phone +971 (0) 4 88 65 878
E-Mail info@sick.ae

USA/México

Phone +1(952) 941-6780
1 (800) 325-7425 – tollfree
E-Mail info@sickusa.com

More representatives and agencies
at www.sick.com