



### Main

Range of Product	Modicon ABE7
Product or Component Type	Electromechanical output relay sub-base
[Us] rated supply voltage	24 V DC PLC end
Number of Channels	16
Number of terminal per channel	2

### Complementary

Terminal block type	Removable
Polarity distribution	Common per group of 8 channels on both poles
Fixing mode	By clips 35 mm symmetrical DIN rail) By screws solid plate with fixing kit)
Maximum current per output common	10 A
Current per channel	5 A preactuator end
Minimum switching current	10 mA $\geq$ 5 V
Drop-out voltage	2.4 V 68 °F (20 °C) PLC end)
Switching frequency	$\leq$ 0.5 Hz $\leq$ 10 Hz
Threshold tripping voltage	19.7 V 104 °F (40 °C)
Drop-out current	1 mA 68 °F (20 °C)
Maximum power dissipation per channel in W	0.36 W PLC end)
Contacts type and composition	1 NO preactuator end
Maximum switching voltage	250 V AC 50/60 Hz IEC 60947-5-1 30 V DC IEC 60947-5-1
Electrical durability	500000 Cycles 600 mA 24 V DC-13 10 ms preactuator end) 500000 Cycles 1500 mA 230 V AC-12 preactuator end) 500000 Cycles 1500 mA 24 V DC-12 preactuator end) 500000 cycles 900 mA 230 V AC-15 preactuator end)
Electrical reliability	1e-008
Operating time	$\leq$ 10 ms coil energisation and NO closing $\leq$ 5 ms coil de-energisation and NO opening
Contact bounce time	$\leq$ 5 ms 1 NO
Operating rate in Hz	10 Hz no load 0.5 Hz at le
Mechanical durability	20000000 cycles
[Uimp] rated impulse withstand voltage	2.5 kV IEC 60947-1
[Ui] Rated Insulation Voltage	2000 V
Installation category	II IEC 60664-1
Tightening torque	5.31 lbf.in (0.6 N.m) flat $\varnothing$ 3.5 mm
Width	8.11 in (206 mm)
Net Weight	0.88 lb(US) (0.4 kg)

The information provided in this documentation contains general descriptions and/or technical characteristics of the performance of the products contained herein. This documentation is not intended as a substitute for and is not to be used for determining suitability or reliability of these products for specific user applications. It is the duty of any such user or integrator to perform the appropriate and complete risk analysis, evaluation and testing of the products with respect to the relevant specific application or use thereof. Neither Schneider Electric Industries SAS nor any of its affiliates or subsidiaries shall be responsible or liable for misuse of the information contained herein.

## Environment

Max immunity to microbreaks	5 ms
Dielectric strength	2000 V IEC 60947-1
Product Certifications	UL[RETURN]CSA[RETURN]JGL[RETURN]DNV[RETURN]EAC
IP degree of protection	IP2X conforming to IEC 60529
Protective treatment	TC
Resistance to incandescent wire	1382 °F (750 °C) 30 s IEC 60695-2-11
Shock resistance	15 gn 11 ms IEC 60068-2-27
Resistance to radiated fields	9.14 V/m (10 V/m) 26000000...1000000000 Hz)IEC 61000-4-3 level 3
Resistance to fast transients	2 kV level 3 IEC 61000-4-4
Ambient air temperature for operation	23...140 °F (-5...60 °C) IEC 61131-2
Ambient air temperature for storage	-40...176 °F (-40...80 °C) IEC 61131-2
Pollution degree	2 IEC 60664-1

## Ordering and shipping details

Category	22375-INTERFACE MODULE(ABA,R,S)
Discount Schedule	CP2
GTIN	3389110545531
Returnability	No
Country of origin	LV

## Packing Units

Unit Type of Package 1	PCE
Number of Units in Package 1	1
Package 1 Height	2.76 in (7.0 cm)
Package 1 Width	3.23 in (8.2 cm)
Package 1 Length	8.35 in (21.2 cm)
Package 1 Weight	20.49 oz (581.0 g)
Unit Type of Package 2	S03
Number of Units in Package 2	16
Package 2 Height	11.81 in (30.0 cm)
Package 2 Width	11.81 in (30.0 cm)
Package 2 Length	15.75 in (40.0 cm)
Package 2 Weight	21.63 lb(US) (9.813 kg)

## Offer Sustainability

Sustainable offer status	Green Premium product
California proposition 65	WARNING: This product can expose you to chemicals including: Lead and lead compounds, which is known to the State of California to cause cancer and birth defects or other reproductive harm. For more information go to <a href="http://www.P65Warnings.ca.gov">www.P65Warnings.ca.gov</a>
REACH Regulation	<a href="#">REACH Declaration</a>
EU RoHS Directive	Pro-active compliance (Product out of EU RoHS legal scope)
Mercury free	Yes
China RoHS Regulation	<a href="#">China RoHS Declaration</a>
RoHS exemption information	<a href="#">Yes</a>
Environmental Disclosure	<a href="#">Product Environmental Profile</a>
Circularity Profile	<a href="#">End Of Life Information</a>
WEEE	The product must be disposed on European Union markets following specific waste collection and never end up in rubbish bins.

## Contractual warranty

Warranty	18 months
----------	-----------

Dimensions

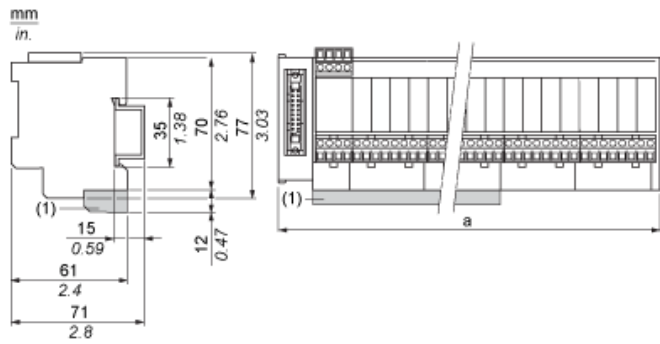

(1) ABE7BV20 / ABE7BV20E

ABE7	a in mm	a in in.
R16S111 / R16S111E	125	4.92
R16S21 / R16S21•E	206	8.11

---

Mounting

---



HE10 16 Channels

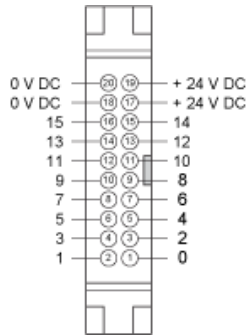

Wiring Diagram

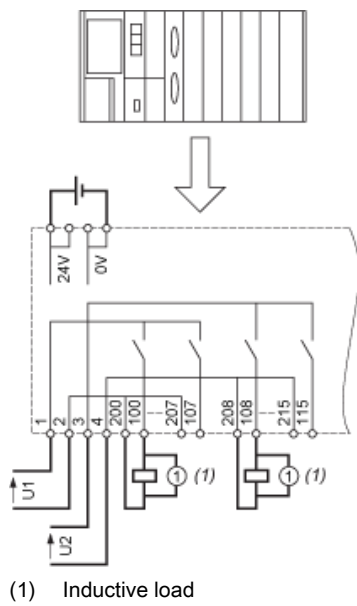

Curves for Determining Cable Type and Length According to the Current

16-channel Sub-base

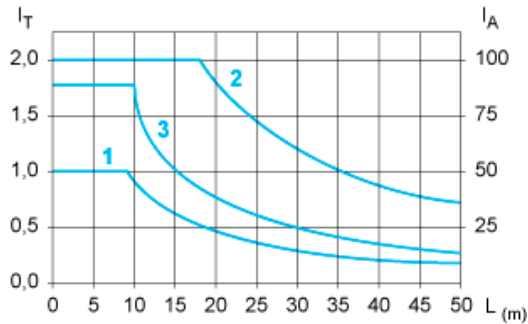

- L Cable length
- $I_T$  Total current per sub base (A)
- $I_A$  Average current per channel (mA)
- (1) TSXCDP••2 and ABFH20H••0 cables with c.s.a.  $0.08 \text{ mm}^2$  (AWG 28).
- (2) TSXCDP••3 cables with c.s.a.  $0.34 \text{ mm}^2$  (AWG 22).
- (3) Cables with c.s.a.  $0.13 \text{ mm}^2$  (AWG 26).

The curves are given for a voltage drop of 1 V in the cable. For n volts tolerance, multiply the length determined from the graph by n.

Temperature Derating Curves

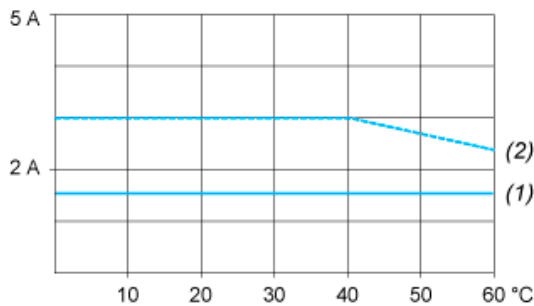

- (1) 100 % of channels used
- (2) 50 % of channels used

Electrical Durability (in Millions of Operating Cycles) Conforming to IEC 60947-5-1

DC Loads

DC12 curves

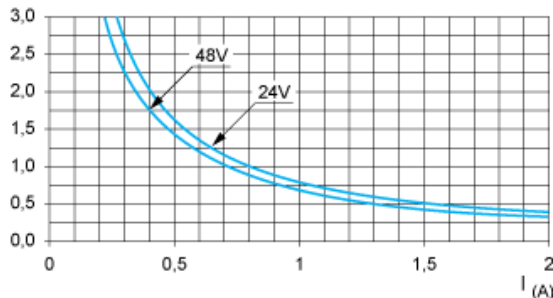

DC12control of resistive loads and of solid state loads isolated by optocoupler,  $I/R \leq 1 \text{ ms}$ .

### DC13 curves

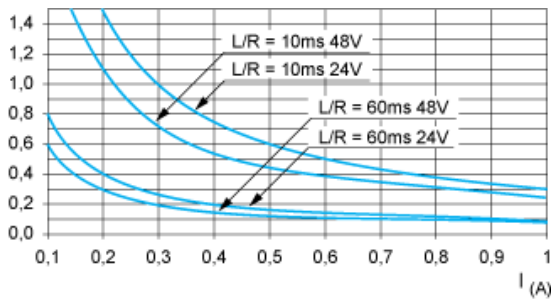

DC13switching electromagnets,  $L/R \leq 2 \times (U_e \times I_e)$  in ms,  $U_e$ : rated operational voltage,  $I_e$ : rated operational current (with a protective diode on the load, DC12 curves must be used with a coefficient of 0.9 applied to the number in millions of operating cycles)

### AC Loads

#### AC12 curves

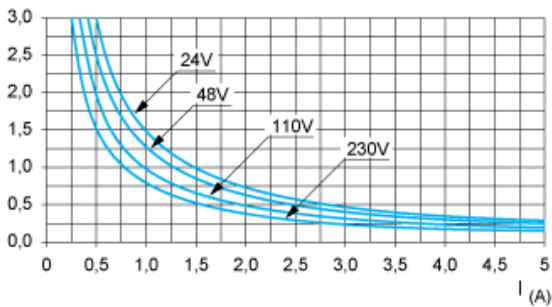

AC12control of resistive loads and of solid state loads isolated by optocoupler,  $\cos \phi \geq 0.9$ .

#### AC14 curves

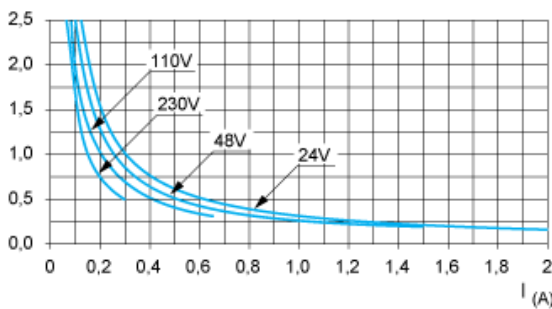

AC14control of small electromagnetic loads  $\leq 72 \text{ VA}$ , make:  $\cos \phi = 0.3$ , break:  $\cos \phi = 0.3$ .

#### AC15 curves

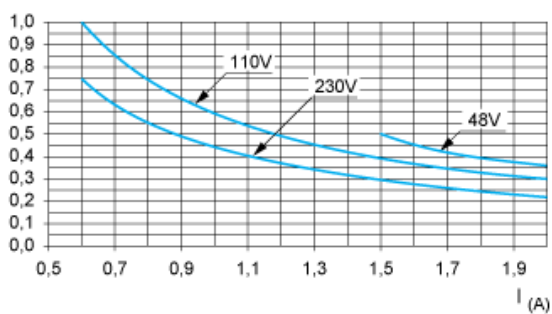

AC15control of electromagnetic loads  $> 72 \text{ VA}$ , make:  $\cos \phi = 0.7$ , break:  $\cos \phi = 0.4$ .