

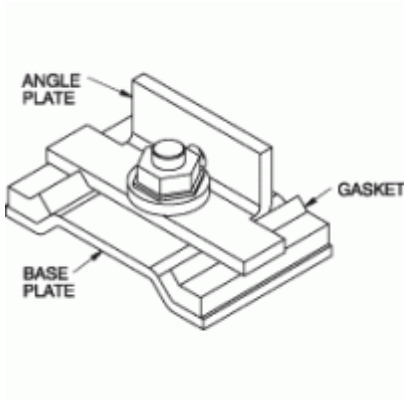

Quality Products. Service Excellence.

Angle Sealing Plate *1485 S9 Series*



Part No.	For use with
1485BS9	2.5 x 2.5
1485CS9	4 x 4
1485DS9	6 x 6
1485ES9	8 x 8
1485FS9	12 x 6

Maintains ratings on CSA and UL approved wireway

Data subject to change without notice



© 2022. Hammond Manufacturing Ltd. All rights reserved.