

Type 4X Polyester Junction Box w/ Raised Lid (Solid and Window) *PJ Series*

Continuous Hinge Door with Snap Latches



Panel
Sold
Separately



Application

- Designed for use as instrument enclosures, electric, hydraulic or pneumatic control housings, electrical junction boxes or terminal wiring enclosures.
- Provides outstanding insulation and protection where equipment may be hosed down or be very wet.
- Ideal in applications with high temperatures or highly corrosive environments.

Standards

- UL 508 Type 1, 2, 3, 4, 4X, 12 and 13
- CSA Type 1, 2, 3, 4, 4X, 12 and 13
- Complies with
 - NEMA Type 1, 2, 3, 4, 4X, 12, & 13
 - IEC 60529, IP66

Construction

- Molded fiberglass polyester enclosure with matching cover is easily punched, cut, or drilled.
- Enhanced UV inhibitors protect against outdoor weathering.
- Standard JIC sizes under 18"x16".
- Threaded brass inserts are provided for optional inner panel or terminal kit mounting. Mounting hardware is included.
- Stainless steel draw type "snap latch" door fasteners.
- Door fasteners include a provision for padlocking.
- Enclosures are available with bonded polycarbonate viewing windows.
- Door is supported with a continuous stainless steel hinge.
- Captive oil resistant gasket provides a positive seal.
- Threaded brass inserts are provided for mounting feet to the rear of the enclosure.
- Stainless steel mounting brackets and hardware are provided for mounting to the rear of the enclosure.
- Operating temperatures between 130°C and -40°C (266°F to -40°F).
- Impact index of 6.78J (5 ft/lb).
- For corrosion resistance information, please refer to table in the Technical Information section.

Finish

- Fiberglass polyester material has a gray finish.
- Optional inner panels are available in white powder coated finished steel or unfinished aluminum, or fiberglass.

Accessories

- PJ/PJU Replacement Hardware Kits
- Swing Panels
- Inner Panels
- Terminal Kit Assemblies

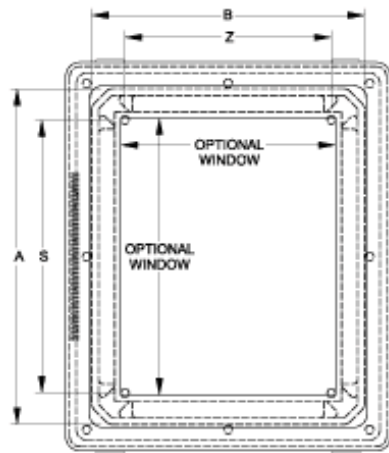

Front View

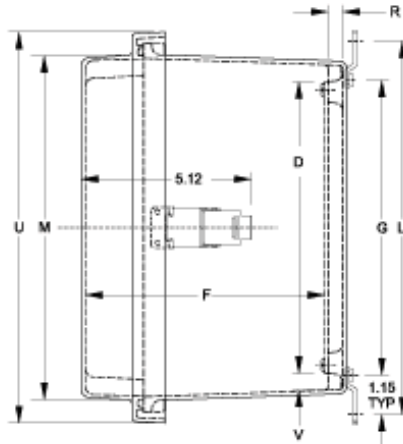

Side View

Latch Locations

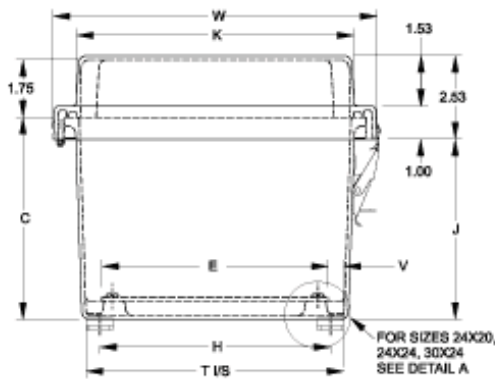
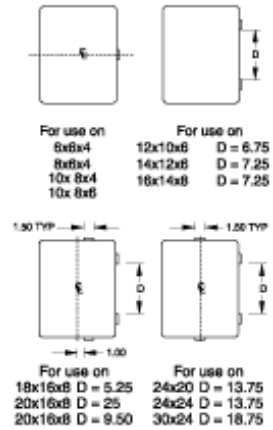

End View

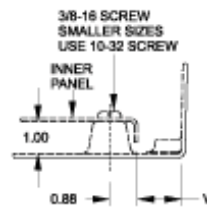

Detail A

Thermal Index
130°C to -40°C (266°F to -40°F)

Impact Index
6.78J (5 ft/lb)

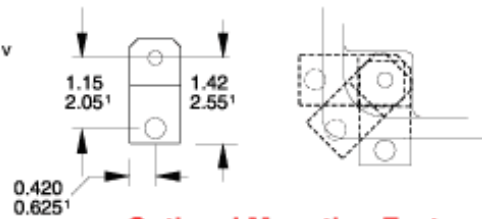

Optional Mounting Feet Locations

Solid Cover Part No.	Window Cover Part No.	Overall Dimensions			Panel Size					Center	
		A	B	C	D	E	G	H	J	S	Z
PJ664RL	PJ664RLW	6.10	6.10	4.18	4.88	4.88	5.01	5.01	3.52	4.25	4.25
PJ864RL	PJ864RLW	8.00	6.12	4.13	6.75	4.88	6.89	5.01	3.47	6.25	4.25
PJ1084RL	PJ1084RLW	10.13	8.26	4.13	8.75	6.88	8.89	7.01	3.47	8.25	6.25
PJ1086RL	PJ1086RLW	10.13	8.26	6.13	8.75	6.88	8.89	7.01	5.47	8.25	6.25
PJ12106RL	PJ12106RLW	12.13	10.26	6.13	10.75	8.88	10.89	9.01	5.47	10.25	8.25
PJ14126RL	PJ14126RLW	14.13	12.26	6.13	12.75	10.88	12.89	11.01	5.47	12.25	10.25
PJ16148RL	PJ16148RLW	16.27	14.40	8.13	14.75	12.88	14.89	13.01	7.47	14.25	12.25
PJ18168RL	PJ18168RLW	18.40	16.40	8.13	16.88	14.88	16.97	14.97	7.47	16.25	14.25
PJ20168RL	PJ20168RLW	20.00	16.00	8.13	18.44	14.44	18.54	14.54	7.47	17.81	13.81
PJ24208RL	PJ24208RLW	24.00	20.00	8.13	21.00	17.00	22.75	18.75	7.47	19.25	15.25
PJ24248RL ¹	PJ24248RLW ¹	24.00	24.00	8.13	21.00	21.00	22.75	22.75	7.47	19.25	19.25
PJ30248RL ¹	PJ30248RLW ¹	30.00	24.00	8.13	27.00	21.00	28.75	22.75	7.47	25.25	19.25
PJ242010RL ¹	PJ242010RLW ¹	24.00	20.00	10.13	21.00	17.00	22.75	18.75	9.47	19.25	15.25
PJ242410RL ¹	PJ242410RLW ¹	24.00	24.00	10.13	21.00	21.00	22.75	22.75	9.47	19.25	19.25
PJ302410RL ¹	PJ302410RLW ¹	30.00	24.00	10.13	27.00	21.00	28.75	22.75	9.47	25.25	19.25

¹ Uses larger mounting foot - See drawing above.

Solid Cover Part No.	Window Cover Part No.	Cover Dimensions								Opt. Panel Part No.	Window Dimensions	
		L	T	K	M	U	W	R	V		Height	Width
PJ664RL	PJ664RLW	7.32	5.83	6.08	6.08	7.70	7.69	0.44	0.49	14R0505	4.25	4.25

Solid Cover Part No.	Window Cover Part No.	Cover Dimensions								Opt. Panel Part No.	Window Dimensions	
		L	T	K	M	U	W	R	V		Height	Width
PJ864RL	PJ864RLW	9.19	5.85	6.11	7.98	9.60	7.71	0.44	0.50	14R0705	6.25	4.25
PJ1084RL	PJ1084RLW	11.19	7.85	8.44	10.32	11.80	9.90	0.44	0.50	14R0907	8.37	6.50
PJ1086RL	PJ1086RLW	11.19	7.85	8.44	10.32	11.80	9.00	0.44	0.50	14R0907	8.37	6.50
PJ12106RL	PJ12106RLW	13.19	9.85	10.45	12.32	13.80	11.90	0.44	0.50	14R1109	10.37	8.50
PJ14126RL	PJ14126RLW	15.19	11.85	12.45	14.32	15.70	13.85	0.44	0.50	14R1311	12.37	10.50
PJ16148RL	PJ16148RLW	17.19	13.71	13.86	15.73	17.90	15.99	0.44	0.50	14R1513	13.00	11.00
PJ18168RL	PJ18168RLW	19.28	15.72	15.86	17.86	20.00	18.00	0.44	0.50	P1868	14.00	12.00
PJ20168RL	PJ20168RLW	20.84	15.31	15.43	19.43	21.60	17.59	0.44	0.52	P2068	15.00	11.00
PJ24208RL	PJ24208RLW	25.06	19.73	20.16	24.16	25.60	21.59	1.00	1.38	18P2117	16.00	12.00
PJ24248RL¹	PJ24248RLW¹	25.06	23.73	24.16	24.16	25.60	25.59	1.00	1.38	18P2121	16.00	16.00
PJ30248RL¹	PJ30248RLW¹	31.06	23.73	24.16	30.16	31.60	25.59	1.00	1.38	18P2721	23.00	17.00
PJ242010RL¹	PJ242010RLW¹	25.06	19.70	20.16	24.16	25.60	21.59	1.00	1.36	18P2117	16.00	12.00
PJ242410RL¹	PJ242410RLW¹	25.06	23.70	24.16	24.16	25.60	25.59	1.00	1.36	18P2121	16.00	16.00
PJ302410RL¹	PJ302410RLW¹	31.06	23.70	24.16	30.16	31.60	25.59	1.00	1.36	18P2721	23.00	17.00

¹ Uses larger mounting foot - See drawing above.

Data subject to change without notice

© 2016. Hammond Manufacturing Ltd. All rights reserved.