



Main

Range of Product	Modicon ABE7
Product or Component Type	Sub-base for plug-in relay
Sub-base type	Output sub-base
[Us] rated supply voltage	19...30 V IEC 61131-2
Number of Channels	16
Connections - terminals	Screw type terminals, 1 x 0.09...1 x 1.5 mm ² AWG 28...AWG 16) flexible with cable end Screw type terminals, 1 x 0.14...1 x 2.5 mm ² AWG 26...AWG 12) solid Screw type terminals, 1 x 0.14...1 x 2.5 mm ² AWG 26...AWG 14) flexible without cable end Screw type terminals, 2 x 0.09...2 x 0.75 mm ² AWG 28...AWG 20) flexible with cable end Screw type terminals, 2 x 0.2...2 x 2.5 mm ² AWG 24...AWG 14) solid
Channel additional information	1 switch disconnecter per channel

Complementary

Supply voltage type	DC
Product Compatibility	ABS7SC3E ABS7A3M ABE7ACC21 ABR7S33 ABS7SC3..
Status LED	1 LED per channel (Green) channel status 1 LED (Green) power ON
Polarity distribution	Polarity distribution contact common per 2 groups of 4 channels
Short-circuit protection	1 A internal fuse, 5 x 20 mm, fast blow PLC end) 2 A fuse per channel, 5 x 20 mm, fast blow output circuit)
Fixing mode	By clips 35 mm symmetrical DIN rail) By screws solid plate with fixing kit)
Maximum supply current	1 A
Voltage drop on power supply fuse	0.3 V
Maximum current per output common	16 A
[Ui] rated insulation voltage	300 V coil circuit/contact circuits IEC 60947-1 2000 V terminals/mounting rails
[Uimp] rated impulse withstand voltage	2.5 kV
Installation category	II IEC 60664-1
Tightening torque	5.31 lbf.in (0.6 N.m) flat Ø 3.5 mm
Width	10.71 in (272 mm)
Height	3.50 in (89 mm)
Depth	2.91 in (74 mm)
Net Weight	2.20 lb(US) (1 kg)

The information provided in this documentation contains general descriptions and/or technical characteristics of the products of the performance of the products contained herein. This documentation is not intended as a substitute for and is not to be used for determining suitability or reliability of these products for specific user applications. It is the duty of any such user or integrator to perform the appropriate and complete risk analysis, evaluation and testing of the products with respect to the relevant specific application or use thereof. Neither Schneider Electric Industries SAS nor any of its affiliates or subsidiaries shall be responsible or liable for misuse of the information contained herein.

Environment

Product Certifications	CSA[RETURN]JUL[RETURN]GL[RETURN]DNV[RETURN]EAC
IP degree of protection	IP2X conforming to IEC 60529
Resistance to incandescent wire	1382 °F (750 °C) 30 s IEC 60695-2-11
Shock resistance	15 gn 11 ms IEC 60068-2-27
Vibration resistance	2 gn 10...150 Hz)IEC 60068-2-6
Resistance to electrostatic discharge	4 KV contact) level 3 IEC 61000-4-2 8 kV air) level 3 IEC 61000-4-2
Resistance to radiated fields	9.14 V/m (10 V/m) 26000000...1000000000 Hz)IEC 61000-4-3 level 3
Resistance to fast transients	2 kV level 3 IEC 61000-4-4
Ambient air temperature for operation	23...140 °F (-5...60 °C) IEC 61131-2
Ambient air temperature for storage	-40...176 °F (-40...80 °C) IEC 61131-2
Pollution degree	2 IEC 60664-1

Ordering and shipping details

Category	22375-INTERFACE MODULE(ABA,R,S)
Discount Schedule	CP2
GTIN	3389110705126
Returnability	No
Country of origin	LV

Packing Units

Unit Type of Package 1	PCE
Number of Units in Package 1	1
Package 1 Height	3.35 in (8.5 cm)
Package 1 Width	3.82 in (9.7 cm)
Package 1 Length	11.50 in (29.2 cm)
Package 1 Weight	31.92 oz (905.0 g)
Unit Type of Package 2	S03
Number of Units in Package 2	6
Package 2 Height	11.81 in (30.0 cm)
Package 2 Width	11.81 in (30.0 cm)
Package 2 Length	15.75 in (40.0 cm)
Package 2 Weight	13.19 lb(US) (5.985 kg)

Offer Sustainability

Sustainable offer status	Green Premium product
California proposition 65	WARNING: This product can expose you to chemicals including: Lead and lead compounds, which is known to the State of California to cause cancer and birth defects or other reproductive harm. For more information go to www.P65Warnings.ca.gov
REACH Regulation	REACH Declaration
EU RoHS Directive	Pro-active compliance (Product out of EU RoHS legal scope)
Mercury free	Yes
China RoHS Regulation	China RoHS Declaration
RoHS exemption information	Yes
Environmental Disclosure	Product Environmental Profile
Circularity Profile	End Of Life Information
WEEE	The product must be disposed on European Union markets following specific waste collection and never end up in rubbish bins.

Contractual warranty

Warranty	18 months
----------	-----------

Dimensions

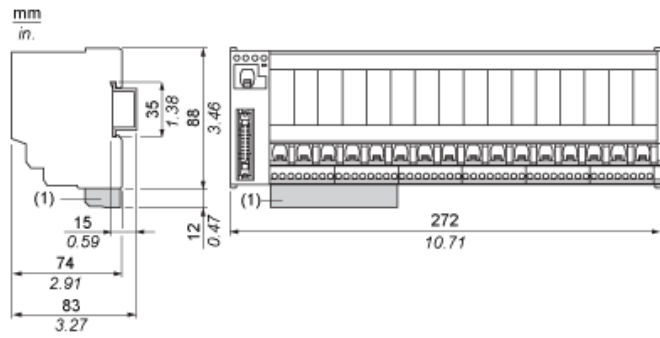

(1) ABE7BV10 / BV20, ABE7BV10E / BV20E

Mounting

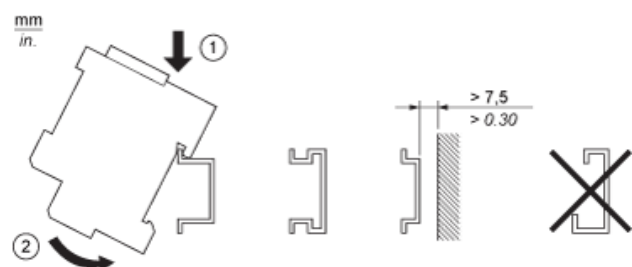

HE10 16 Channels

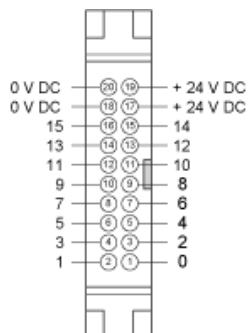

Wiring Diagram

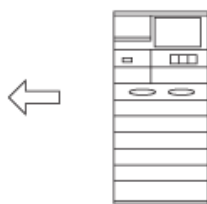
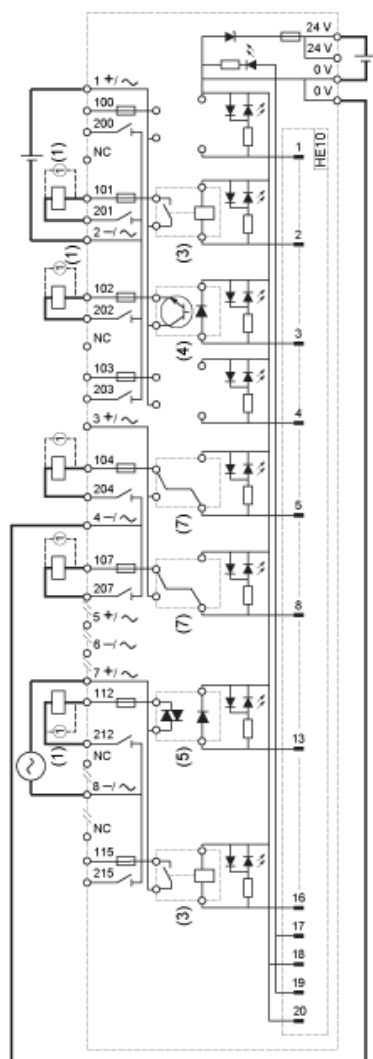

- (1) Inductive load
- (3) ABR7S33 (1 "OF" "DPDT") I_{th} = 10 A (supplied)
- (4) ABS7SC3E (5...48 VDC) I_{max.} = 1.5 A (not supplied)
- (5) ABS7SA3M (24...240 VAC) I_{max.} = 1.5 A (not supplied)
- (7) ABE7ACC21 (24 VDC) I_{max.} = 0.5 A (not supplied)

Curves for Determining Cable Type and Length According to the Current

16-channel Sub-base

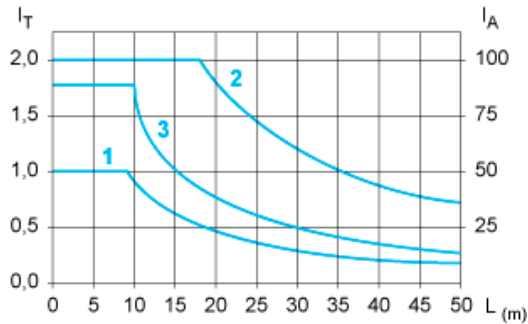

- L Cable length
 I_T Total current per sub base (A)
 I_A Average current per channel (mA)
 (1) TSXCDP••2 and ABFH20H••0 cables with c.s.a. 0.08 mm^2 (AWG 28).
 (2) TSXCDP••3 cables with c.s.a. 0.34 mm^2 (AWG 22).
 (3) Cables with c.s.a. 0.13 mm^2 (AWG 26).

The curves are given for a voltage drop of 1 V in the cable. For n volts tolerance, multiply the length determined from the graph by n.

Temperature Derating Curves

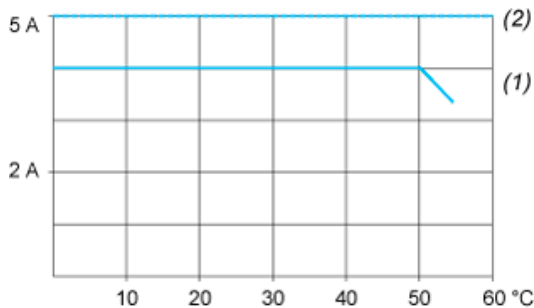

- (1) 100 % of channels used
 (2) 50 % of channels used

Electrical Durability (in Millions of Operating Cycles) Conforming to IEC 60947-5-1

DC Loads

DC12 curves

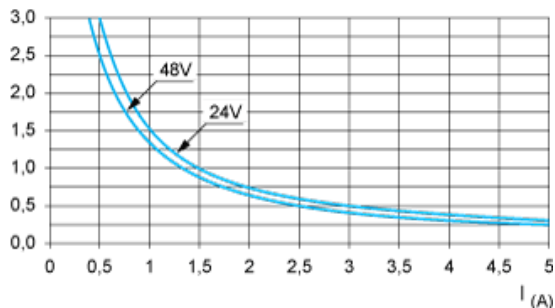

DC12control of resistive loads and of solid state loads isolated by optocoupler, $I/R \leq 1 \text{ ms}$.

DC13 curves

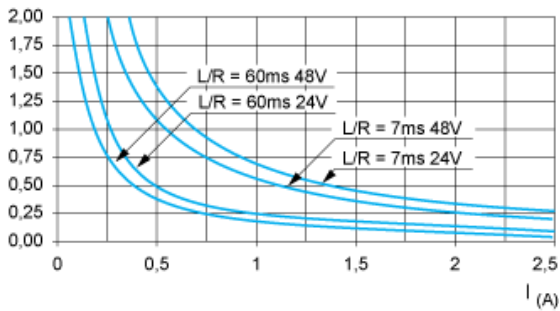

DC13 Switching electromagnets, $L/R \leq 2 \times (U_e \times I_e)$ in ms, U_e : rated operational voltage, I_e : rated operational current (with a protective diode on the load, DC12 curves must be used with a coefficient of 0.9 applied to the number in millions of operating cycles)

AC Loads

AC12 curves

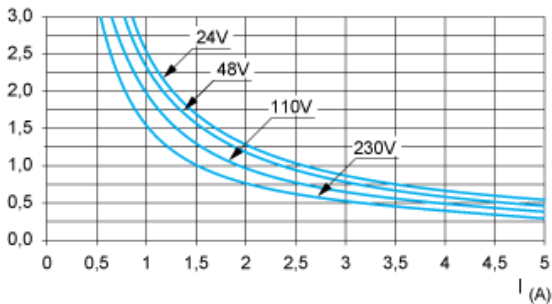

AC12 control of resistive loads and of solid state loads isolated by optocoupler, $\cos \phi \geq 0.9$.

AC14 curves

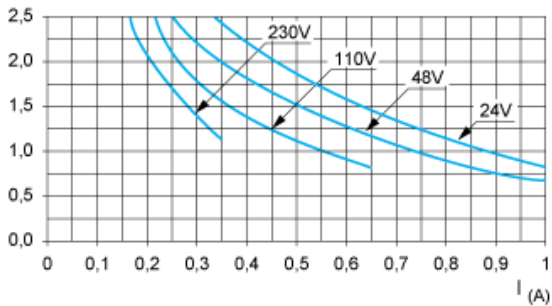

AC14 control of small electromagnetic loads ≤ 72 VA, make: $\cos \phi = 0.3$, break: $\cos \phi = 0.3$.

AC15 curves

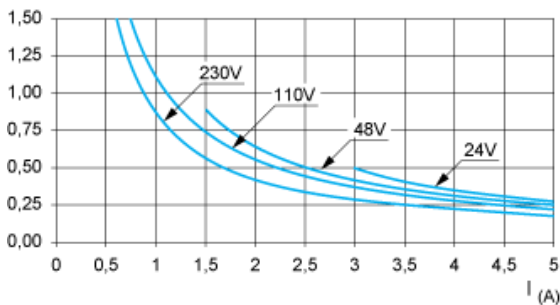

AC15 control of electromagnetic loads > 72 VA, make: $\cos \phi = 0.7$, break: $\cos \phi = 0.4$.