

Rectangular Floor Boxes for Wood Floors

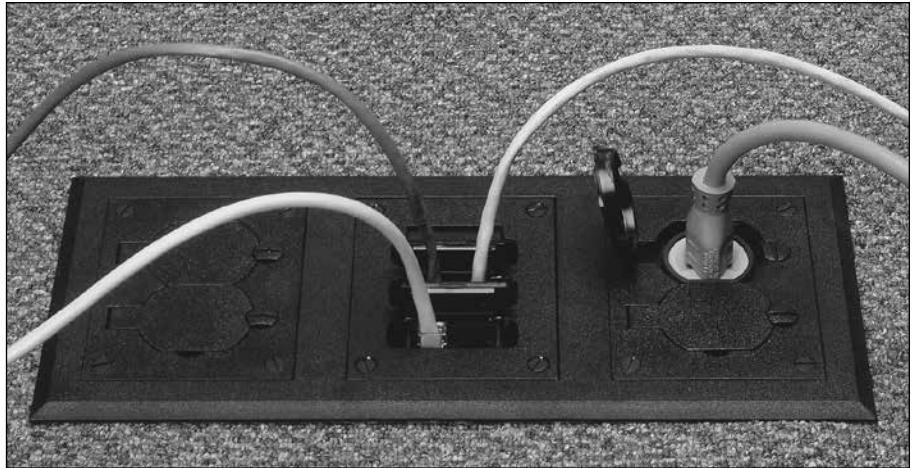

880W Series™ Wood Floor Boxes provides an excellent solution for unique wood floor applications when power and communication services are required in remote locations, as in a large, open space area. This wood floor box series is available in a rectangular design in one-, two-, or three-gang configurations and can be used in any wood frame construction.

880W Series Wood Floor Boxes have many different applications. Some of those include upscale housing, home offices, board rooms, and gymnasiums.



Three-Gang 880W Series Floor Box shown with a nonmetallic cover for a multiservice application.

FEATURES & BENEFITS

- **TopGuard protection.** An integral design which keeps out water, dirt, and debris from the power or communication compartments. Whenever you see the TopGuard protection icon applied to any Wiremold product, you will know that he product meets and exceeds the new UL scrub water exclusion requirement.
- **New brushed aluminum covers for power applications.** 830CK Series Aluminum Covers have been redesigned to now accept threaded conduit when passing through power cables.
- **New brass and brushed aluminum covers to accept single locking power receptacles.** New 828DLR Series provides single flip lid cover.
- **New 828COMTC Series Cover Kit in brass and brushed aluminum.** Allows communication devices to be recessed into 880W Series Boxes.
- **Available in one-, two-, and three-gang configurations.** Multiservice separation and even greater capacity when divider is removed. Eliminates cost of using multiple floor boxes for high capacity requirements.
- **Triple service capacity.** Accommodates power, communication and/or audio/video devices. Eliminates the need for multiple boxes 
- **BAA Aluminum Covers.** Rectangular aluminum covers are now available in a version that complies with the Buy America Act and ARRA requirements. Covers are available in five powder coat finishes (black, gray, bronze, brass and nickel) 
- **Flush activation assembly.** Same activation assemblies as Walker concrete floor boxes. Wide range of aesthetically pleasing brass and nonmetallic activations that do not obstruct the floor area or create a safety hazard.
- **Datacom connectivity options.** Accepts industry standard and proprietary devices from a wide range of manufacturers to provide a seamless and aesthetically pleasing interface for voice, data, audio, and video applications at the point-of-use. A wide selection of data and adapter options available for use with Ortronics® TracJack™ and Series II devices.
- **Boxes and covers have been listed by Underwriters Laboratories Inc. to their standard UL514A, 514C, 514D, and Canadian standard C22.2.**



Protection from water, dirt, and debris.

880W Series Floor Boxes Ordering Information

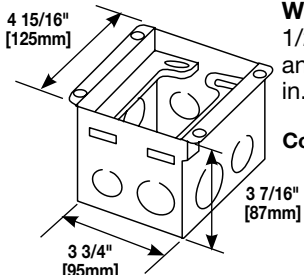
Catalog No./Item	Description/Specifications
880W1 	One-Gang Steel Floor Box for Wood Floors – Knockouts for three 1/2" [12.7mm], five 3/4" [19.1mm], and two 1" [25mm] conduits. 53 cu. in. [869ml] of capacity. Country of Origin: Mexico

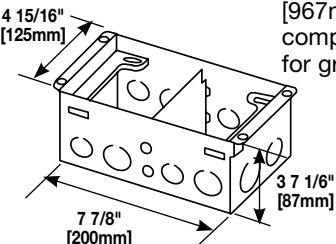
880W2 	Two-Gang Steel Floor Box for Wood Floors – Knockouts for six 1/2" [12.7mm], eight 3/4" [19.1mm], and two 1" [25mm] conduits. 58 cu. in. [951ml] of capacity in one compartment. 59 cu. in. [967ml] of capacity in second compartment. Barrier is removable for greater capacity if needed. Country of Origin: Mexico
---	---

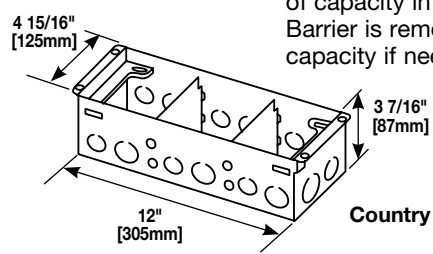
Catalog No./Item	Description/Specifications
880W3 	Three-Gang Steel Floor Box for Wood Floors – Knockouts for nine 1/2" [12.7mm], eleven 3/4" [19.1mm], and two 1" [25mm] conduits. 56 cu. in. [918ml] of capacity in each of the outside compartments. 68 cu. in. [1115ml] of capacity in center compartment. Barrier is removable for greater capacity if needed. Country of Origin: Mexico

880W Series Floor Box Kits Ordering Information

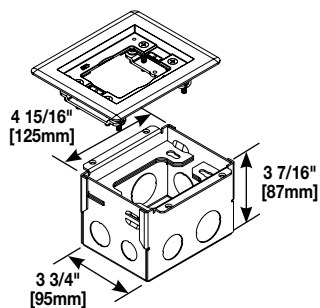
Catalog No./Item	Description/Specifications
880W1817B 	One-Gang Steel Floor Box for Wood Floors – 880W1 Floor Box with 817B brass flange included. Flange can be used for tile or carpet applications. Country of Origin: Mexico NOTE: Order cover separately.

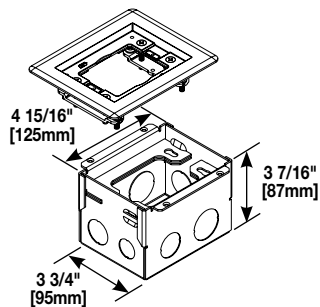
880W1818TCAL 	One-Gang Steel Floor Box for Wood Floors – 880W1 Floor Box with 818TCAL brushed aluminum flange included. Flange can be used for tile or carpet applications. Country of Origin: Mexico NOTE: Order cover separately.
--	--

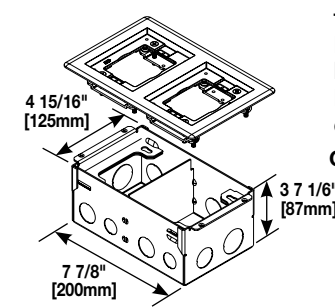
Catalog No./Item	Description/Specifications
880W2827B 	Two-Gang Steel Floor Box for Wood Floors – 880W2 Floor Box with 827B brass flange included. Flange can be used for tile or carpet applications. Country of Origin: Mexico NOTE: Order cover separately.

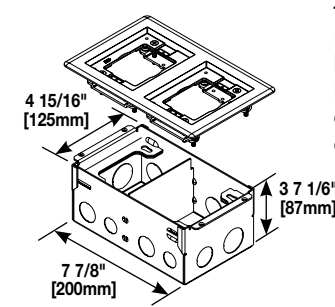
880W2828TCAL 	Two-Gang Steel Floor Box for Wood Floors – 880W2 Floor Box with 828TCAL brushed aluminum flange included. Flange can be used for tile or carpet applications. Country of Origin: Mexico NOTE: Order cover separately.
---	--

880W Series Floor Box Kits Ordering Information (continued)

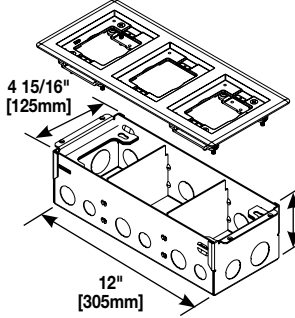
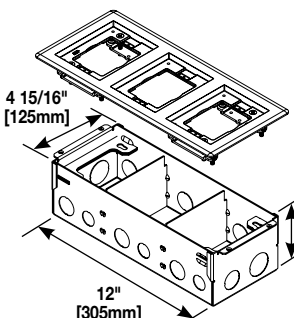
Catalog No./Item	Description/Specifications
<p>880W3837B</p> 	<p>Three-Gang Steel Floor Box for Wood Floors – 880W3 Floor Box with 837B brass flange included. Flange can be used for tile or carpet applications.</p> <p>Country of Origin: Mexico</p> <p>NOTE: Order cover separately.</p>
<p>880W3838TCAL</p> 	<p>One-Gang Steel Floor Box for Wood Floors – 880W3 Floor Box with 838TCAL brushed aluminum flange included. Flange can be used for tile or carpet applications.</p> <p>Country of Origin: Mexico</p> <p>NOTE: Order cover separately.</p>

880W Series Floor Boxes Solid Brass Cover Plate Flanges Ordering Information

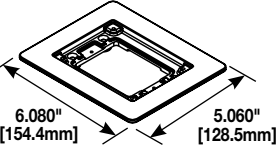
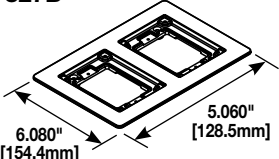
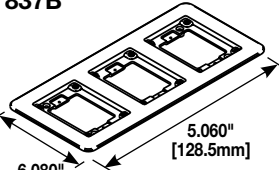
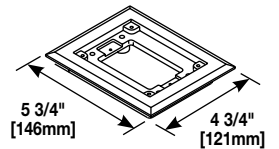
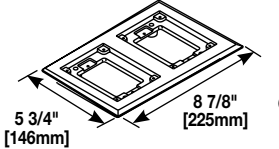
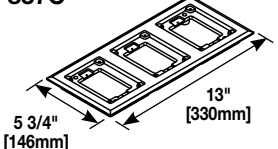
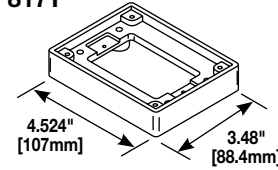
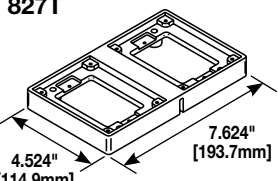
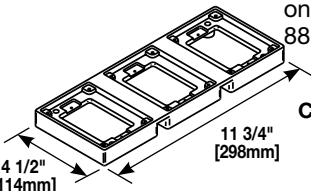
Catalog No./Item	Description/Specifications
<p>817B</p> 	<p>One-Gang Brass Combination Carpet & Tile Flange – Accepts Ortronics® MAB6TJ TracJack and MAB3S2 Series II adapters and Wiremold CM Series inserts, sold separately.</p> <p>Country of Origin: China</p>
<p>827B</p> 	<p>Two-Gang Brass Combination Carpet and Tile Flange – Accepts Ortronics® MAB6TJ TracJack and MAB3S2 Series II adapters and Wiremold CM Series inserts, sold separately.</p> <p>Country of Origin: China</p>
<p>837B</p> 	<p>Three-Gang Brass Combination Carpet and Tile Flange – Accepts Ortronics® MAB6TJ TracJack and MAB3S2 Series II adapters and Wiremold CM Series inserts, sold separately.</p> <p>Country of Origin: China</p>
<p>817C</p> 	<p>One-Gang Brass Carpet Flange – For use on 880S1, 880M1, 880CS1-1, and 880CM1-1 Floor Boxes.</p> <p>Country of Origin: China</p>
<p>827C</p> 	<p>Two-Gang Brass Carpet Flange – For use on 880S2, 880M2, 880CS2-1, and 880CM2-1 Floor Boxes.</p> <p>Country of Origin: China</p>
<p>837C</p> 	<p>Three-Gang Brass Carpet Flange – For use on 880S3, 880M3, 880CS32-1, and 880CM3-1 Floor Boxes.</p> <p>Country of Origin: China</p>
<p>817T</p> 	<p>One-Gang Brass Tile Flange – For use on 880S1, 880M1, 880CS1-1, and 880M1-1 Floor Boxes.</p> <p>Country of Origin: China</p>
<p>827T</p> 	<p>Two-Gang Brass Tile Flange – For use on 880S2, 880M2, 880CS2-1, and 880CM2-1 Floor Boxes.</p> <p>Country of Origin: China</p>
<p>837T</p> 	<p>Three-Gang Brass or Brushed Aluminum Tile Flange – For use on 880S3, 880M3, 880CS3-1, and 880CM3-1 Floor Boxes.</p> <p>Country of Origin: China</p>

NOTE: Brass covers and flanges are not interchangeable with aluminum or nonmetallic covers and flanges. Nonmetallic covers are interchangeable with aluminum flanges.

All cover assemblies for the 880W Series Floor Box have TopGuard protection.

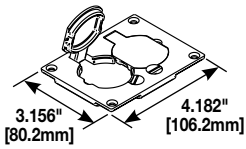
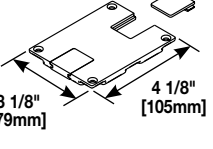
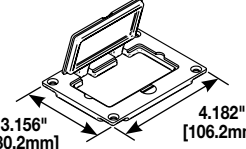
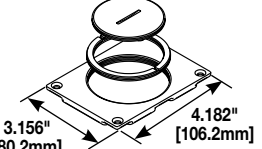
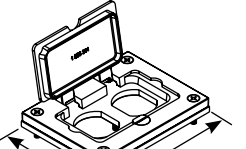
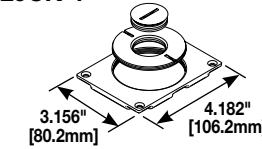
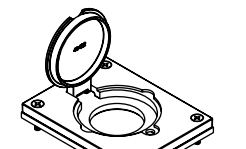
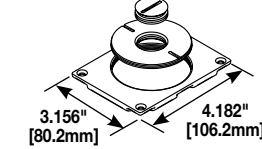
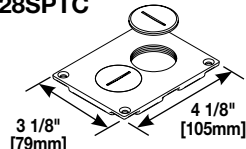
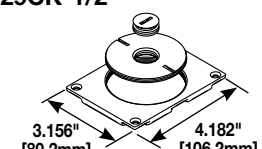
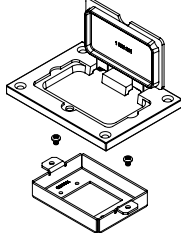

880W Series Floor Boxes Metal Cover Plates Ordering Information

Catalog No./Item	Description/Specifications	Catalog No./Item	Description/Specifications
828R 	Brass Duplex Cover Plate – Flip lids. Can also be used with a 106 type communication adapter. Country of Origin: China	829STC 	Brass Communication Cover Plate – Data slides. Feed through only, not for use with a mounting plate for communication jacks. Country of Origin: China
828GFITC 	Brass GFI Cover Plate – May be used with Activate and Ortronics® Connectivity Systems in conjunction with 817B, 827B, and 837B Flanges. Country of Origin: China	829CK 	Brass Communication Cover Plate – 2 5/8" and 2 1/4" [67mm and 57mm] plugs. Country of Origin: China
828DPGFITC 	Brass Rectangular Cover Plate – Allows for mounting of a duplex style receptacle with a rectangular style flip lid cover. Country of Origin: China	829CK-1 	Brass Communication Cover Plate – 2 5/8" and 1" [67mm and 25mm] plugs. Country of Origin: China
828DLR 	Brass Single Locking Receptacle Cover Plate – Single flip lid cover for 20A or 30A single locking receptacles. Device opening is 2 5/8" [67mm]. For use with maximum female locking device of 1.58" diameter, and maximum male plug face of 2.25" diameter Country of Origin: China	829CK-3/4 	Brass Communication Cover Plate – 2 5/8" and 3/4" [67mm and 19.1mm] plugs. Country of Origin: China
828SPTC 	Brass Duplex Cover Plate – Screw plugs. Screw plugs are 1 1/2" [38mm] in diameter. Country of Origin: China	829CK-1/2 	Brass Communication Cover Plate – 2 5/8" and 1/2" [67mm and 12.7mm] plugs. Country of Origin: China
		828MAAP 	<div style="text-align: right;">NEW!</div> A/V Adapter Plate – Sheet metal adapter plate that accepts two (2) Extron® Electronics MAAP style device plates (sold separately). For use with 828GFITC or 828GFITCAL cover plates. (Sold separately) Country of Origin: USA

NOTE: Brass covers and flanges are not interchangeable with aluminum or nonmetallic covers and flanges. Nonmetallic covers are interchangeable with aluminum flanges.

All cover assemblies for the 880W Series Floor Box have TopGuard protection.

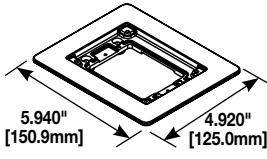
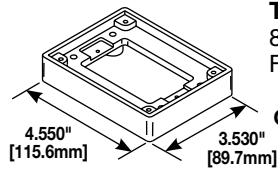
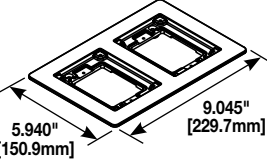
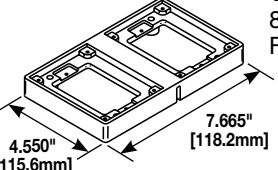
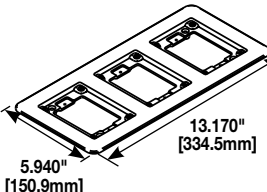
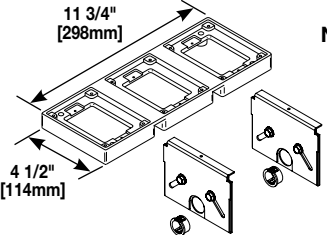

880W Series Floor Boxes Brushed Aluminum Cover Plate Flanges Ordering Information

Catalog No./Item	Description/Specifications
<p>818TCAL</p>  <p style="text-align: center;">Country of Origin: China</p> <p>NOTE: Brushed aluminum flanges come with beveled edges.</p>	<p>818TAL</p> <p>One-Gang Brushed Aluminum Tile Flange – For use on 880S1, 880M1, 880CS1-1, and 880M1-1 Floor Boxes.</p>  <p style="text-align: center;">Country of Origin: China</p>
<p>828TCAL</p>  <p style="text-align: center;">Country of Origin: China</p> <p>NOTE: Brushed aluminum flanges come with beveled edges.</p>	<p>828TAL</p> <p>Two-Gang Brushed Aluminum Tile Flange – For use on 880S2, 880M2, 880CS2-1, and 880CM2-1 Floor Boxes.</p>  <p style="text-align: center;">Country of Origin: China</p>
<p>838TCAL</p>  <p style="text-align: center;">Country of Origin: China</p> <p>NOTE: Brushed aluminum flanges come with beveled edges.</p>	<p>838TAL-880S3 838TAL-880M3 838TAL-880CS3 838TAL-880CM3</p> <p>Kit – The 838TAL-880 Series flanges provide additional tile load support for 3-gang tile flanges. Kit includes 838TAL Flange and two support dividers.</p>  <p style="text-align: center;">Country of Origin: China</p> <p>NOTE: Order kit for specific box type: 880S3, 880M3, 880CS3, or 880CM3.</p>

NOTE: Brass covers and flanges are not interchangeable with aluminum or nonmetallic covers and flanges. Nonmetallic covers are interchangeable with aluminum flanges.

All cover assemblies for the 880W Series Floor Box have TopGuard protection.

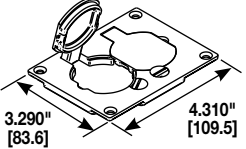
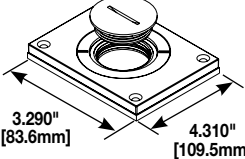
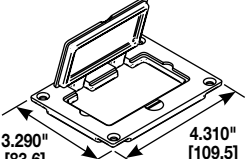
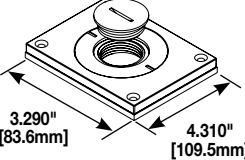
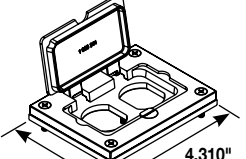
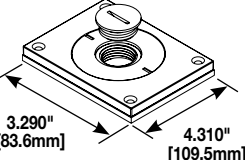
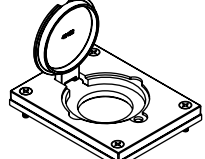
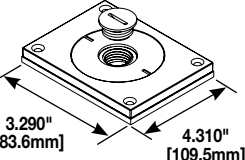
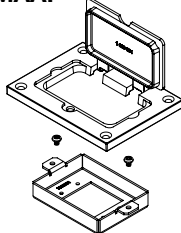

880W Series Floor Boxes Metal Cover Plates Ordering Information

Catalog No./Item	Description/Specifications	Catalog No./Item	Description/Specifications
828R-TCAL 	Brushed Aluminum Duplex Cover Plate – Flip lids. Can also be used with a 106 type communication adapter. Country of Origin: China	830KTCAL 	Brushed Aluminum Cover Plate – Power or communication plate with 2" [51mm] and 1 1/4" [32mm] plugs. Country of Origin: China NOTE: Acceptable for use with threaded conduit when passing through power cables.
828GFITCAL 	Brushed Aluminum GFI Cover Plate – May be used with Activate and Ortronics® Connectivity Systems in conjunction with 817B, 827B, and 837B Flanges. Country of Origin: China	830KTCAL-1 	Brushed Aluminum Cover Plate – Power or communication plate with 2" [51mm] and 1" [25mm] plugs. Country of Origin: China NOTE: Acceptable for use with threaded conduit when passing through power cables.
828DPGFITCAL 	Brushed Aluminum Rectangular Cover Plate – Allows for mounting of a duplex style receptacle with a rectangular style flip lid cover. Country of Origin: China	830KTCAL-3/4 	Brushed Aluminum Cover Plate – Power or communication plate with 2" [51mm] and 3/4" [19.1mm] plugs. Country of Origin: China NOTE: Acceptable for use with threaded conduit when passing through power cables.
828DLRAL 	Brushed Aluminum Single Locking Receptacle Cover Plate – Single flip lid cover for 20A or 30A single locking receptacles. Device opening is 2 5/8" [67mm]. For use with maximum female locking device of 1.58" diameter, and maximum male plug face of 2.25" diameter Country of Origin: China	830KTCAL-1/2 	Brushed Aluminum Cover Plate – Power or communication plate with 2" [51mm] and 1/2" [12.7mm] plugs. Country of Origin: China NOTE: Acceptable for use with threaded conduit when passing through power cables.
		828MAAP 	A/V Adapter Plate – Sheet metal adapter plate that accepts two (2) Extron® Electronics MAAP style device plates (sold separately). For use with 828GFITC or 828GFITCAL cover plates. (Sold separately) Country of Origin: USA

NOTE: Brass covers and flanges are not interchangeable with aluminum or nonmetallic covers and flanges. Nonmetallic covers are interchangeable with aluminum flanges.

All cover assemblies for the 880W Series Floor Box have TopGuard protection.

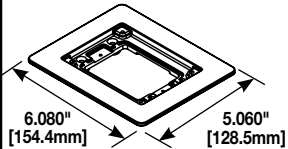
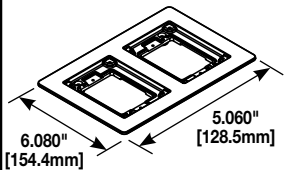
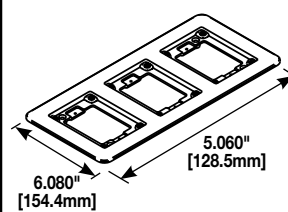
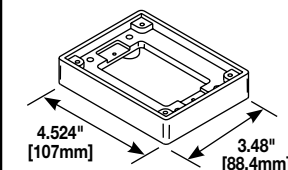
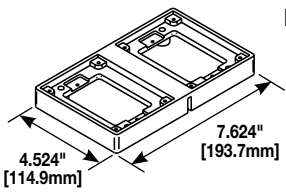
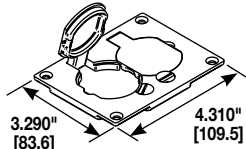
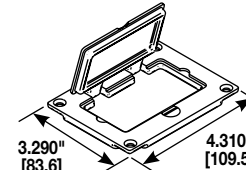
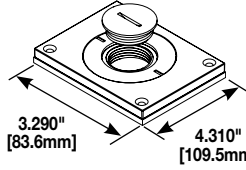

880W Series Floor Boxes Powder-Coated Aluminum Cover Plate Flanges Ordering Information

Catalog No./Item	Description/Specifications
<p>817TCAL-BK 817TCAL-GY 817TCAL-BS 817TCAL-NK 817TCAL-BZ</p>  <p style="text-align: center;">6.080" [154.4mm] 5.060" [128.5mm]</p>	<p>One-Gang Powder-Coated Aluminum Combination Carpet and Tile Flange – Accepts Ortronics® MAB6TJ TracJack and MAB3S2 Series II adapters and Wiremold CM Series inserts, sold separately. Flanges are available in five decorative colors: black, gray brass, nickel and bronze.</p> <p style="text-align: center;">Country of Origin: USA</p>
<p>827TCAL-BK 827TCAL-GY 827TCAL-BS 827TCAL-NK 827TCAL-BZ</p>  <p style="text-align: center;">6.080" [154.4mm] 5.060" [128.5mm]</p>	<p>Two-Gang Powder-Coated Aluminum Combination Carpet and Tile Flange – Accepts Ortronics® MAB6TJ TracJack and MAB3S2 Series II adapters and Wiremold CM Series inserts, sold separately. Flanges are available in five decorative colors: black, gray brass, nickel and bronze.</p> <p style="text-align: center;">Country of Origin: USA</p>
<p>837TCAL-BK 837TCAL-GY 837TCAL-BS 837TCAL-NK 837TCAL-BZ</p>  <p style="text-align: center;">6.080" [154.4mm] 5.060" [128.5mm]</p>	<p>Three-Gang Powder-Coated Aluminum Combination Carpet and Tile Flange – Accepts Ortronics® MAB6TJ TracJack and MAB3S2 Series II adapters and Wiremold CM Series inserts, sold separately. Flanges are available in five decorative colors: black, gray brass, nickel and bronze.</p> <p style="text-align: center;">Country of Origin: USA</p>
<p>817TAL-BK 817TAL-GY 817TAL-BS 817TAL-NK 817TAL-BZ</p>  <p style="text-align: center;">4.524" [107mm] 3.48" [88.4mm]</p>	<p>One-Gang Powder-Coated Aluminum Tile Flange – For use on 880S1, 880M1, 880CS1-1, and 880M1-1 Floor Boxes. Flanges are available in five decorative colors: black, gray brass, nickel and bronze.</p> <p style="text-align: center;">Country of Origin: USA</p>
<p>827TAL-BK 827TAL-GY 827TAL-BS 827TAL-NK 827TAL-BZ</p>  <p style="text-align: center;">4.524" [114.9mm] 7.624" [193.7mm]</p>	<p>Two-Gang Powder-Coated Aluminum Tile Flange – For use on 880S2, 880M2, 880CS2-1, and 880CM2-1 Floor Boxes. Flanges are available in five decorative colors: black, gray brass, nickel and bronze.</p> <p style="text-align: center;">Country of Origin: USA</p>
<p>828R-TCAL-BK 828R-TCAL-GY 828R-TCAL-BS 828R-TCAL-NK 828R-TCAL-BZ</p>  <p style="text-align: center;">3.290" [83.6] 4.310" [109.5]</p>	<p>Powder-Coated Aluminum Duplex Cover Plate – Flip lids. Can also be used with a 106 type communication adapter.</p> <p style="text-align: center;">Country of Origin: USA</p>
<p>828GFITCAL-BK 828GFITCAL-GY 828GFITCAL-BS 828GFITCAL-NK 828GFITCAL-BZ</p>  <p style="text-align: center;">3.290" [83.6] 4.310" [109.5]</p>	<p>Powder-Coated Aluminum Rectangular Cover Plate – Allows for mounting a duplex receptacle (Decorator or GFCI style) with a rectangular flip cover</p> <p style="text-align: center;">Country of Origin: USA</p>
<p>829CKAL-1BK 829CKAL-1GY 829CKAL-1BS 829CKAL-1NK 829CKAL-1BZ</p>  <p style="text-align: center;">3.290" [83.6mm] 4.310" [109.5mm]</p>	<p>Powder-Coated Aluminum Cover Plate – Power or communication plate with 2" [51mm] and 1" [25mm] plugs. Covers are available in five decorative colors: black, gray brass, nickel and bronze.</p> <p style="text-align: center;">Country of Origin: USA</p> <p>NOTE: Acceptable for use with threaded conduit when passing through power cables.</p>

NOTE: Brass covers and flanges are not interchangeable with aluminum or nonmetallic covers and flanges. Nonmetallic covers are interchangeable with aluminum flanges.

All cover assemblies for the 880W Series Floor Box have TopGuard protection.

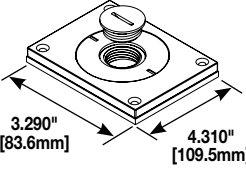

OmniBox Series Floor Boxes Powder-Coated Aluminum Cover Plate Flanges Ordering Information (Continued)

Catalog No./Item	Description/Specifications
<p>829CKAL-3/4BK 829CKAL-3/4GY 829CKAL-3/4BS 829CKAL-3/4NK 829CKAL-3/4BZ</p>  <p style="text-align: center;">Country of Origin: USA</p> <p style="text-align: center;">NOTE: Acceptable for use with threaded conduit when passing through power cables.</p>	<p>Powder-Coated Aluminum Cover Plate – Power or communication plate with 2" [51mm] and 3/4" [19.1mm] plugs. Covers are available in five decorative colors: black, gray brass, nickel and bronze.</p>

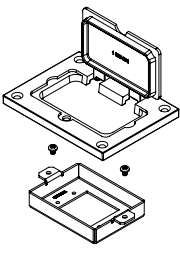
Catalog No./Item	Description/Specifications
<p>828MAAP</p>  <p style="text-align: center;">Country of Origin: USA</p>	<p>A/V Adapter Plate – Sheet metal adapter plate that accepts two (2) Extron® Electronics MAAP style device plates (sold separately). For use with 828GFITC or 828GFITCAL cover plates. (Sold separately)</p>

880W Series Floor Boxes Nonmetallic Cover Plate Flanges Ordering Information

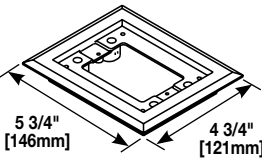
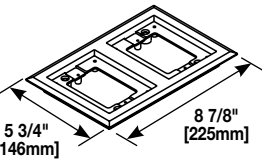
Catalog No./Item	Description/Specifications
<p>817PCC-BLK 817PCC-BRN</p>  <p style="text-align: center;">Country of Origin: Mexico</p>	<p>One-Gang Nonmetallic Carpet Flange – Available in black or brown. For Ortronics® connectivity use with 829PFLRT Cover. For Activate connectivity use with 829PFL Cover. Accepts Ortronics® MAB6TJ TracJack and MAB3S2 Series II adapters and Wiremold CM Series inserts, sold separately.</p>
<p>827PCC-BLK 827PCC-BRN</p>  <p style="text-align: center;">Country of Origin: Mexico</p>	<p>Two-Gang Nonmetallic Carpet Flange – Available in black or brown. For Ortronics® connectivity use with 829PFLRT Cover. For Activate connectivity use with 829PFL Cover. Accepts Ortronics® MAB6TJ TracJack and MAB3S2 Series II adapters and Wiremold CM Series inserts, sold separately.</p>

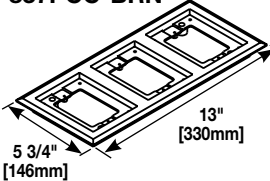
Catalog No./Item	Description/Specifications
<p>837PCC-BLK 837PCC-BRN</p>  <p style="text-align: center;">Country of Origin: Mexico</p>	<p>Three-Gang Nonmetallic Flange – Available in black or brown. For Ortronics® connectivity use with 829PFLRT Cover. For Activate connectivity use with 829PFL Cover. Accepts Ortronics® MAB6TJ TracJack and MAB3S2 Series II adapters and Wiremold CM Series inserts, sold separately.</p>

NOTE: UL Listed for tile, terrazzo, and carpet floors.
Brass covers and flanges are not interchangeable with aluminum or nonmetallic covers and flanges. Nonmetallic covers are interchangeable with aluminum flanges.

NOTE: Brass covers and flanges are not interchangeable with aluminum or nonmetallic covers and flanges. Nonmetallic covers are interchangeable with aluminum flanges.

All cover assemblies for the 880W Series Floor Box have TopGuard protection.

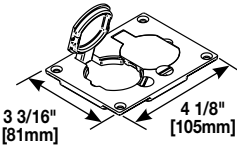
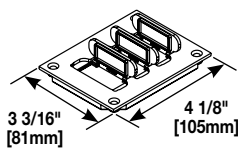
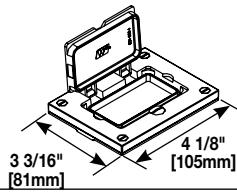
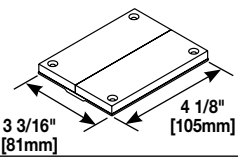
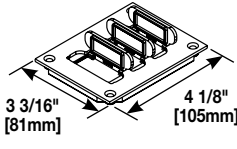
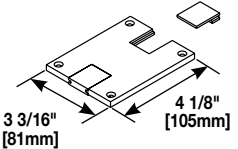

880W Series Floor Boxes Nonmetallic Cover Plates Ordering Information

Catalog No./Item	Description/Specifications	Catalog No./Item	Description/Specifications
828PR-BLK 828PR-BRN 	<p>Nonmetallic Duplex Cover Plate – Flip lids. Available in black or brown. Can also be used with a 106 type communication adapter.</p> <p>Country of Origin: USA</p>	829PFLRT-BLK 829PFLRT-BRN 	<p>Nonmetallic Communication Cover Plate – Individual flip lids.* Available in black or brown. Gasket included. Ortronics® MAB6TJ TracJack and MAB3S2 Series II adapters included.</p> <p>Country of Origin: USA</p>
828PRGFI-BLK 828PRGFI-BRN 	<p>Nonmetallic GFI Cover Plate – Available in black or brown. May be used with Ortronics® Connectivity systems in conjunction with 817, 827 and 837PCC Series flanges.</p> <p>Country of Origin: USA</p>	829PCK-BLK 829PCK-BRN 	<p>Nonmetallic Communication Cover Plate – Breakouts. Available in black or brown. Feed through only, not for use with a mounting plate for communication jacks.</p> <p>Country of Origin: USA</p>
829PFL-BLK 829PFL-BRN 	<p>Nonmetallic Communication Cover Plate – Individual flip lids.* Available in black or brown. Gasket included. Wiremold CM Series inserts included.</p> <p>Country of Origin: USA</p>	829PSTC-BLK 829PSTC-BRN 	<p>Nonmetallic Communication Cover Plate – Data slides. Available in black or brown. Feed through only, not for use with a mounting plate for communication jacks.</p> <p>Country of Origin: USA</p>

NOTE: Brass covers and flanges are not interchangeable with aluminum or nonmetallic covers and flanges. Nonmetallic covers are interchangeable with aluminum flanges.

All cover assemblies for the 880W Series Floor Box have TopGuard protection.



Mounting Options for Connectivity Inserts

Brass Cover Plate Mounting Option

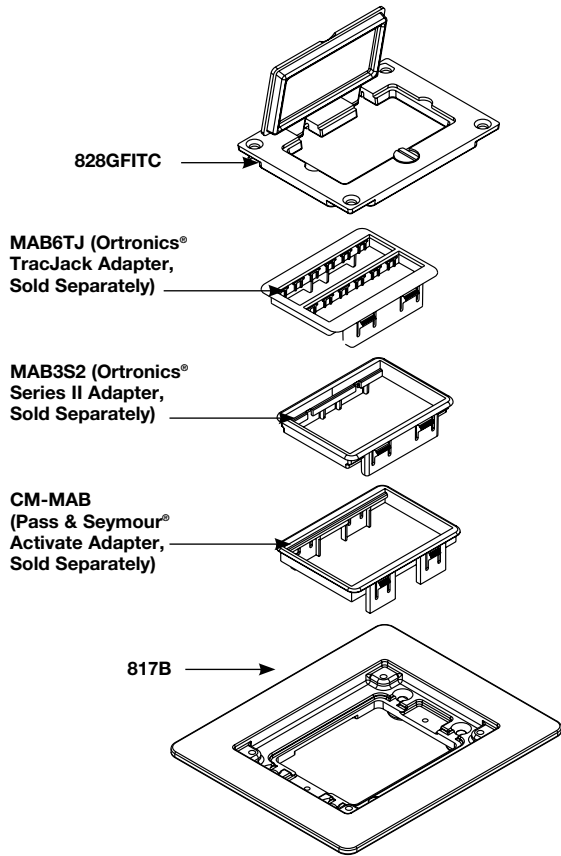

Pass & Seymour® Activate and Ortronics® inserts are sold separately. Mounting methods typical for two- and three-gang versions.

Nonmetallic Cover Plate Mounting Option

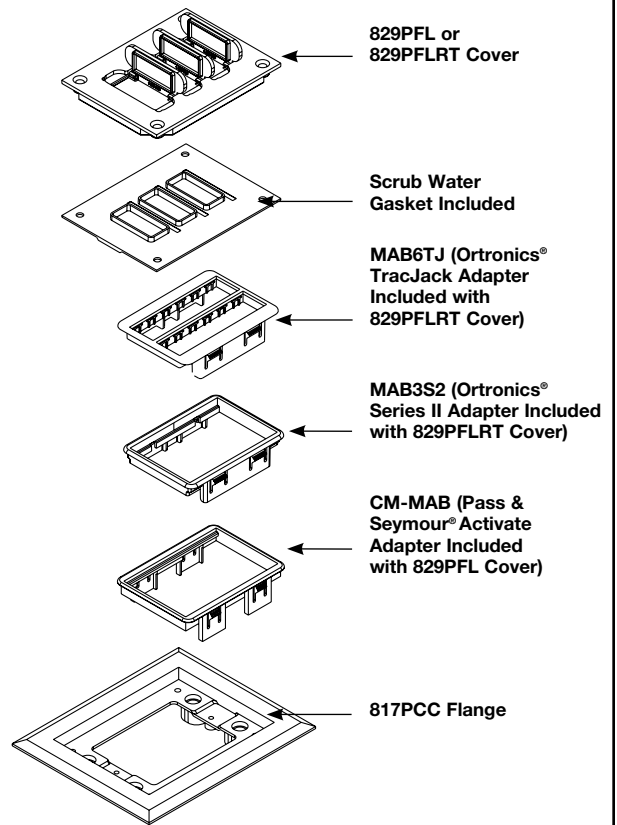

Pass & Seymour® Activate and Ortronics® inserts are sold separately. Mounting method typical for two- and three-gang versions. Part is scrub water approved for use on tile floors. To maintain scrub water resistance, blank connectivity inserts must be inserted in unused openings.

NOTE: The 828GFITC Cover must remain open on some inserts.

NOTE: 829PFL Cover must remain open on some Activate connectivity inserts.