

## ACT20X-HDI-SDO-RNC-S

**Weidmüller Interface GmbH & Co. KG**  
Klingenbergstraße 26  
D-32758 Detmold  
Germany

www.weidmueller.com

### Product image, Similar to illustration



The ACT20X-HDI-SDO/ 2HDI-2SNO RNO/RNC isolating switch amplifiers are specially designed for recording NAMUR sensor signals and digital switching signals which originate from Ex zone 0.

Switching relays, optionally available with NO or NC contacts, transfer output signals to the safe zone.

Integrated alarm contacts issue an alert in the event of a malfunction; this makes troubleshooting easier and increases system availability.

The rail mounted disconnect-switch amplifiers are optionally available in one- or two-channel versions.

With 11 mm width per channel, the devices need little space in the electrical cabinet.

### General ordering data

Version	EX signal isolating converter, Ex-input: NAMUR sensor/switch, Safe-output: relay, NC contact, 1-channel
Order No.	<a href="#">8965350000</a>
Type	ACT20X-HDI-SDO-RNC-S
GTIN (EAN)	4032248784868
Qty.	1 pc(s).

## ACT20X-HDI-SDO-RNC-S

**Weidmüller Interface GmbH & Co. KG**

Klingenbergstraße 26

D-32758 Detmold

Germany

www.weidmueller.com

## Technical data

### Dimensions and weights

Depth	113.6 mm	Depth (inches)	4.472 inch
Height	119.2 mm	Height (inches)	4.693 inch
Width	22.5 mm	Width (inches)	0.886 inch
Net weight	175 g		

### Temperatures

Storage temperature	-20 °C...85 °C	Operating temperature	-20 °C...60 °C
Humidity	0...95 % (no condensation)		

### Probability of failure

SIL PAPER	SIL certificate	SIL in compliance with IEC 61508	2
MTBF	207 a		

### Assembling

Mounting position	horizontal or vertical	Rail	TS 35
Type of mounting	Snap mounting support rail		

### Input EX

Input frequency	<20 Hz	Input resistance	1 kΩ
NAMUR supply	8 V DC / 8 mA	Output signal in case of wire break	<0.1 mA, > 6.5 mA (in case of wire break)
Pulse duration	> 0.1 ms	Resistance	RP = 750 Ω / RS = 15kΩ
Sensor	NAMUR sensor, according to EN60947-5-6, switch with or without RS, RP	Sensor supply	8 V DC / 8 mA
Trigger level high	> 2.1 mA	Trigger level low	<1.2 mA
Type	intrinsically safe circuit		

### Digital output

Continuous current	≤ 2 A AC/DC (safe area, Zone 2 area)	Function	Output = input, direct or inverse (configurable)
Max. switching frequency	20 Hz	Nominal switching voltage	≤ 250 V AC / 30 V DC (safe area) ≤ 32 V AC / 32 V DC (zone 2)
Switching capacity	500 VA / 60 W (safe area), 16 VA / 60 W (zone 2)	Type	Relay, 1 NC contact, Switching frequency 20 Hz

### Alarm output

Alarm function	Line interruption at the input, Short circuit at input, No supply voltage, Device error	Continuous current	≤ 0.5 A AC / 0.3 A DC (safe zone), ≤ 0.5 A AC / 1 A DC (zone 2)
Nominal switching voltage	≤ 125 V AC / 110 V DC (safe area) ≤ 32 V AC / 32 V DC (zone 2)	Power rating	≤ 62.5 VA / 32 W (safe area) ≤ 16 VA / 32 W (Zone 2)
Type	Status relay, 1 NC (voltage-free)		

Creation date November 26, 2024 12:32:12 PM CET

Catalogue status 26.11.2024 / We reserve the right to make technical changes.

2

## ACT20X-HDI-SDO-RNC-S

**Weidmüller Interface GmbH & Co. KG**

Klingenbergstraße 26

D-32758 Detmold

Germany

www.weidmueller.com

## Technical data

### General specifications

Configuration	With FDT/DTM software, Requires configuration adapter 8978580000 CBX200 USB	Humidity	0...95 % (no condensation)
Operating altitude	≤ 2000 m	Power consumption	≤ 1.3 W
Protection degree	IP20	Type of connection	Screw connection
Voltage supply	19.2...31.2 V DC		

### Insulation coordination

EMC standards	EN 61326-1	Insulation voltage	2.6 kV (input / output)
Rated voltage	300 V	Standards	EN 61010-1

### Data for Ex applications (ATEX)

Current I <sub>0</sub>	12 mA DC	Installation location	Device installed in safe area, zone 2
Marking	II (1) G [Ex ia Ga] IIC/IIB/ IIA, II (1) D [Ex ia Da] IIIC, I (M1) [Ex ia Ma] I	Power P <sub>0</sub>	32 mW
Voltage U <sub>0</sub>	10.6 V DC		

### Safety-related basic specifications

Description of the "safe state"	de-energized (relay output)	Device type	B
Diagnostic test interval	10 s	T <sub>proof</sub>	4 a
Total failure rate for safe detected failures (λ <sub>SD</sub> )	0 FIT	Hardware fault tolerance (HFT)	0
Safety category	SIL 2	Relay lifetime	100000 times
Safe Failure Fraction (SFF)	90 %	Mean Time To Repair (MTTR)	8 h
Total failure rate for safe undetected failures (λ <sub>SU</sub> )	289 FIT	Total failure rate for dangerous detected failures (λ <sub>DD</sub> )	130 FIT
Total failure rate for dangerous undetected failures (λ <sub>DU</sub> )	46 FIT	Probability of outage PFH	4.66 x 10 <sup>-8</sup> h <sup>-1</sup>
Demand mode	High	Demand rate	1,000 s
Demand response time	<10 ms (relay output)		

### Safety-related specifications Low demand mode

Safe Failure Fraction (SFF)	90 %	Average Probability of Failure on Demand (PFD <sub>avg</sub> )	2.04 x 10 <sup>-4</sup> (T <sub>proof</sub> = 1 year), 4.08 x 10 <sup>-4</sup> (T <sub>proof</sub> = 2 years), 1.02 x 10 <sup>-4</sup> (T <sub>proof</sub> = 5 years)
-----------------------------	------	--	--

### Connection data

Type of connection	Screw connection	Tightening torque, min.	0.4 Nm
Tightening torque, max.	0.6 Nm	Clamping range, rated connection	2.5 mm <sup>2</sup>
Clamping range, min.	0.25 mm <sup>2</sup>	Clamping range, max.	2.5 mm <sup>2</sup>
Wire connection cross section AWG, min.	AWG 26	Wire connection cross section AWG, max.	AWG 12

### Guarantee

Time interval	3 years
---------------	---------

Creation date November 26, 2024 12:32:12 PM CET

## ACT20X-HDI-SDO-RNC-S

**Weidmüller Interface GmbH & Co. KG**  
Klingenbergstraße 26  
D-32758 Detmold  
Germany

[www.weidmueller.com](http://www.weidmueller.com)

## Technical data

### Classifications

ETIM 6.0	EC002653	ETIM 7.0	EC002653
ETIM 8.0	EC002653	ETIM 9.0	EC002653
ECLASS 9.0	27-21-01-20	ECLASS 9.1	27-21-01-20
ECLASS 10.0	27-21-01-20	ECLASS 11.0	27-21-01-20
ECLASS 12.0	27-21-01-20	ECLASS 13.0	27-21-01-20
ECLASS 14.0	27-21-01-20		

**ACT20X-HDI-SDO-RNC-S**

**Weidmüller Interface GmbH & Co. KG**  
 Klingenbergstraße 26  
 D-32758 Detmold  
 Germany

www.weidmueller.com

**Technical data**

**Tender specification sheets**

Long specification

Short specification

**Ex isolating switch amplifiers for Namur sensors**  
**1-channel isolating switch amplifiers in 22.5 mm width with an external power supply, to transmit and isolate Namur sensor signals from Ex zones 0,1,2 into the safe zone.**  
**On the output side there is a potential-free relay contact with opening function and an alarm contact ("a" contact) for status/error messages.**  
 The component can be configured using standard FDT/DTM software.

**Add-on housing for TS35 DIN rail installation**  
**Dimensions: L/W/H 119.2/ 22.5/ 113.6**  
**screw connection/ nominal cross-section 2.5 mm<sup>2</sup>**  
**Protection degree: IP20** Input-  
**NAMUR sensor according to EN 60947** 8  
**VDC / 8 mA sensor power supply**  
**0 to 5 kHz input frequency**  
**wire-break detection**  
 output Relay  
 1 NC contact 250  
 VAC / 30 VDC @ 2A safe zone 32  
 VAC @ 0.5 A/ 32 VDC @ 1 A zone 2 Alarm output relay 1 NO contact 250  
 VAC / 30 VDC @ 2A safe zone  
 32 VAC @ 0.5 A/ 32 VDC @ 1 A zone 2  
 Auxiliary power  
 19 to 31.2 VDC Power loss approx. 1.8 W Ambient temperature range -20 °C to +60 °C

**Secure isolation EN 61010, 3-way isolation up to 2.6 kV AC/DC of all circuits against each other**  
**Working voltage 300 V AC/DC at overvoltage category II and pollution de-**

**ACT20X-HDI-SDO-RNC-S****Weidmüller Interface GmbH & Co. KG**

Klingenbergstraße 26

D-32758 Detmold

Germany

www.weidmueller.com

**Technical data****Environmental Product Compliance**

RoHS Compliance Status	Compliant with exemption
RoHS Exemption (if applicable/known)	7a, 7cl
REACH SVHC	Lead 7439-92-1
SCIP	2f6dd957-421a-46db-a0c2-cf1609156924

**Approvals**

Approvals



Approvals	DNVGL;
ROHS	Conform
UL File Number Search	UL Website
Certificate no. (cULus)	E337701

**Downloads**

Approval/Certificate/Document of Conformity	<a href="#">Application notes – Certification SIL</a> <a href="#">Certification DNV GL</a> <a href="#">Application notes – Certification ATEX</a> <a href="#">Application notes – Certification IECEX</a> <a href="#">UL certification for canada</a> <a href="#">Declaration of Conformity</a>
Engineering Data	<a href="#">CAD data – STEP</a>
Software	<a href="#">WI-Manager, DTM-Library for online installation</a> <a href="#">Release notes for Weidmueller FDT-DTM Software version</a>
User Documentation	<a href="#">Instruction sheet</a> <a href="#">Application notes – Safety Manual for SIL application</a> <a href="#">Handbuch ACT20X- Serie, deutsch</a> <a href="#">Manual ACT20X- series, english</a> <a href="#">20210120 Security Advisory - WI-Manager affected by MundM Software fdtCONTAINER vulnerability</a>
Catalogues	<a href="#">Catalogues in PDF-format</a>
Brochures	

**ACT20X-HDI-SDO-RNC-S**

**Weidmüller Interface GmbH & Co. KG**  
 Klängenbergstraße 26  
 D-32758 Detmold  
 Germany

www.weidmueller.com

**Drawings**

**Connection diagram**

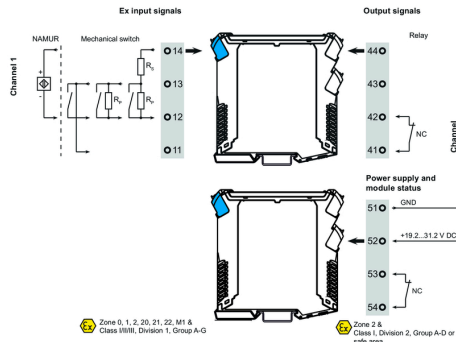

**Application**

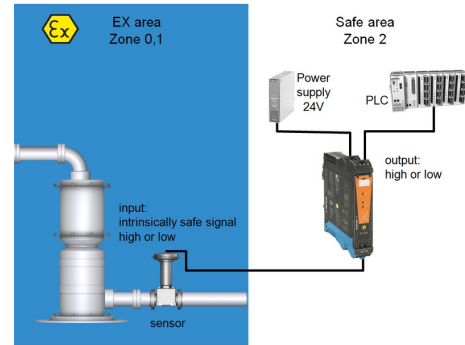

**Block diagram**

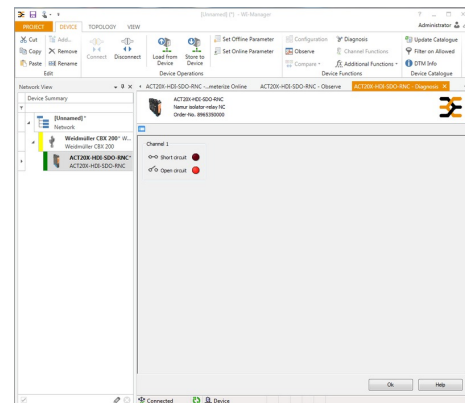
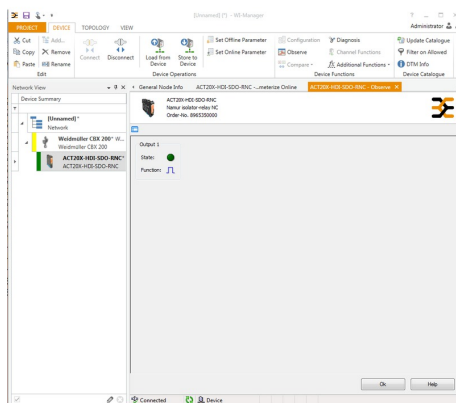
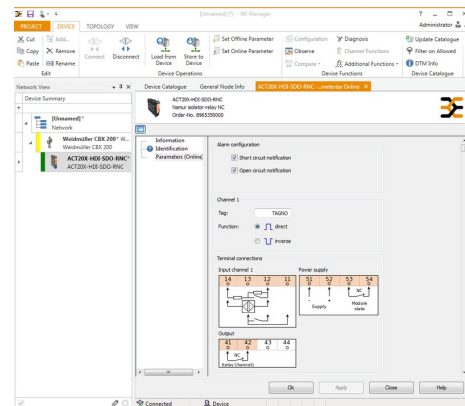
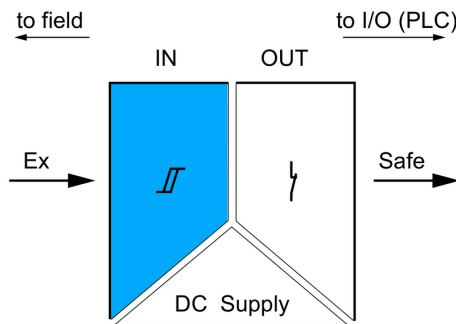

screenshot of configuration with FDT2 / DTM software

screenshot of "observe" with FDT2 / DTM software

**ACT20X-HDI-SDO-RNC-S**

**Weidmüller Interface GmbH & Co. KG**  
Klingenbergstraße 26  
D-32758 Detmold  
Germany

[www.weidmueller.com](http://www.weidmueller.com)

**Drawings**

**Dimensioned drawing**

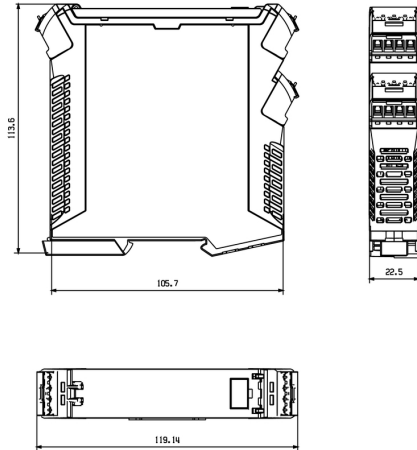

Removable terminals with coding