

Owner's Manual



DUCTLESS SINGLE ZONE HEAT PUMP

23-20 SEER INVERTER
9 000 to 24 000 BTU/hr

Models:
OCD09KCH23S
OCD12KCH22S
OCD18KCH20S
OCD24KCH20S



*Please read this owner's manual carefully
before operating the unit and keep it for future reference.*

TABLE OF CONTENTS

Operation notices	3
Explanation of symbols	3
Precautions.....	4
Working temperature range	6
Parts name.....	7
Indoor unit screen display	8
Remote control	9
Buttons on remote control	9
Icon identification on remote control display	9
Operation of remote control.....	10
Special functions	14
Replacement of batteries in remote control.....	15
Emergency operation.....	16
Maintenance	17
Cleaning and maintenance.....	17
Malfunction	19
Malfunction analysis	19
Error codes.....	21
Preparation before installation	22
Required installation clearance distances diagram.....	22
Tools required for installation.....	23
Selection of installation location.....	23
Requirements for electrical connection	24
Installation	25
Installation of indoor unit	25
Installation of outdoor unit	29
Vacuum pumping.....	32
Leakage detection.....	33
Checking after installation	33
Operation test	34
Other considerations	35
Configuration of connection pipes	35
Pipe expanding method.....	36

This appliance is not intended for use by people (including children) with reduced physical, sensory or mental capabilities, or lack of experience and knowledge, unless they are under the supervision or instruction concerning use of the appliance by a person responsible for their safety. Children should be supervised to ensure that they do not play with the appliance.

OPERATION NOTICES

EXPLANATION OF SYMBOLS



DANGER

Indicates a hazardous situation that, if not avoided, will result in serious injury or death.



WARNING

Indicates a hazardous situation that, if not avoided, could result in serious injury or death.



CAUTION

Indicates a hazardous situation that, if not avoided, may result in minor or moderate injury.

NOTICE

Indicates important but not hazard-related information, used to indicate risk of property damage.



Indicates a hazard and it is assigned to the signal words DANGER, WARNING or CAUTION.

PRECAUTIONS



WARNING

Operation and Maintenance

- This appliance can be used by people (including children of 8 years old and above) with reduced physical, sensory or mental capabilities, or lack of experience and knowledge, as long as they are under the supervision or instruction concerning use of the appliance by a person responsible for their safety.
- Children shall not play with the appliance.
- Cleaning and user maintenance shall not be made by children.
- Do not connect to multi-purpose socket. Otherwise, it may cause fire hazard.
- Disconnect power supply when cleaning. Otherwise, it may cause electric shock.
- If the power supply wire is damaged, it must be replaced by a qualified person in order to avoid a hazard.
- Do not wash with water to avoid electric shock.
- Do not spray water on indoor unit. It may cause electric shock or malfunction.
- After removing the filter, do not touch fins to avoid injury.
- Do not use fire or hair dryer to dry the filter to avoid deformation or fire hazard.
- Maintenance must be performed by qualified person. Otherwise, it may cause personal injury or damage.
- Do not repair the appliance by yourself. It may cause electric shock or damage. Please contact a qualified person when you need to repair it.
- Do not extend fingers or objects into air inlet or air outlet. It may cause personal injury or damage.
- Do not block air outlet or air inlet. It may cause malfunction.
- Do not spill water on the remote control, otherwise it could damage the remote.
- When below phenomenon occurs, please turn off the appliance and disconnect power immediately, and then contact a qualified person for service:
 - There's abnormal sound during operation.
 - Circuit break trips off frequently.
 - The appliance gives off burning smell.
 - Indoor unit is leaking.
- If the appliance operates in an inappropriate environment or under abnormal conditions, it may cause malfunction, electric shock or fire hazard.
- When turning on or turning off the unit by emergency operation button, please press this button with an insulated object other than metal.
- Do not step on top panel of outdoor unit, or put on heavy objects. It may cause damage or personal injury.

PRECAUTIONS



WARNING

Wiring

- Installation must be performed by a qualified person. Otherwise, it may cause personal injury or damage.
- Must follow the electric safety regulations when installing the unit.
- According to the local safety regulations, use qualified power supply circuit and circuit breaker.
- Install a circuit breaker of adequate capacity only used for the system; otherwise, it may cause malfunction.
- An all-pole disconnection switch having a contact separation of at least 3 mm in all poles should be connected in fixed wiring.
- The appliance should be properly grounded. Incorrect grounding may cause electric shock.
- Make sure the power supply matches with the requirement of the appliance. Unstable power supply or incorrect wiring may cause malfunction of the unit, electric shock or fire hazard.
- Properly connect the live wire, neutral wire and grounding wire.
- Be sure to cut off the power supply before proceeding any work related to electricity and safety.
- Do not turn the power on before finishing installation.
- If the supply cord is damaged, it must be replaced by a qualified person in order to avoid problems.
- The temperature of refrigerant circuit will be high, please keep the interconnection cable away from the copper tube.
- The appliance shall be installed in accordance with national wiring regulations.
- Installation must be performed in accordance with the requirement of NEC and CEC by a qualified person only.
- The heat pump is a first class electric appliance. It must be properly grounded with specialized grounding device by a qualified person. Please make sure it is always properly grounded, otherwise it may cause electric shock.
- The yellow-green wire in the appliance is the grounding wire, which can't be used for other purposes.
- The grounding resistance should comply with national electric safety regulations.
- All wires of indoor unit and outdoor unit should be connected by a qualified person.
- If the length of power connection wire is insufficient, please contact the dealer for a new one. Do not extend the wire yourself.

PRECAUTIONS



WARNING

Location

- If you need to relocate the appliance to another place, only a qualified person can perform the work. Otherwise, it may cause personal injury or damage.
- Select a location which is out of reach for children and far away from animals or plants. If it is unavoidable, please add a fence around the outdoor unit for safety purpose.
- Instructions for installation and use of this product are provided by the manufacturer.

WORKING TEMPERATURE RANGE

	Indoor side DB/WB (°C / °F)	Outdoor side DB/WB (°C / °F)
Max. cooling	26.7/19.4 (80/66.9)	46.1/23.9 (115/75)
Max. heating	26.7/- (80/-)	23.9/18.3 (75/64.9)

NOTICE

The operating temperature range (outdoor temperature) is:
-25 °C (-13 °F) to 46.1 °C (115 °F).

PARTS NAME

NOTICE

Actual product may be different from below graphics, please refer to actual product for reference purposes.

Indoor unit

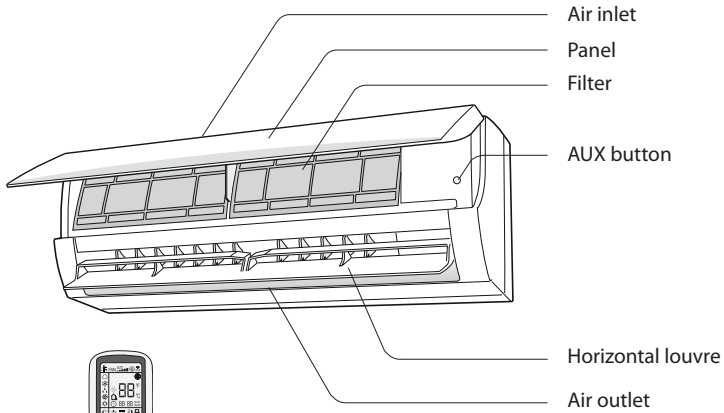

Remote Control

Outdoor unit

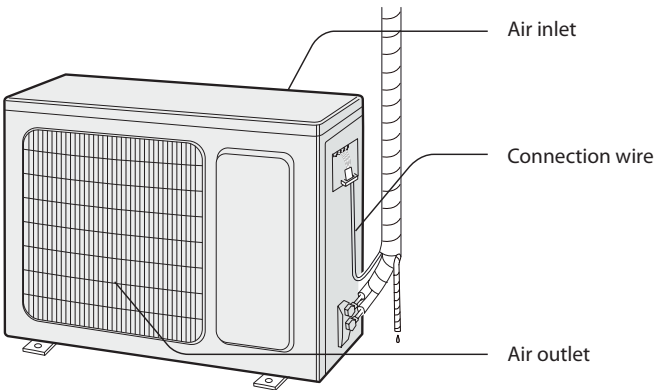

INDOOR UNIT SCREEN DISPLAY

NOTICE

Actual product may be different from below graphics, please refer to actual product for reference purposes.

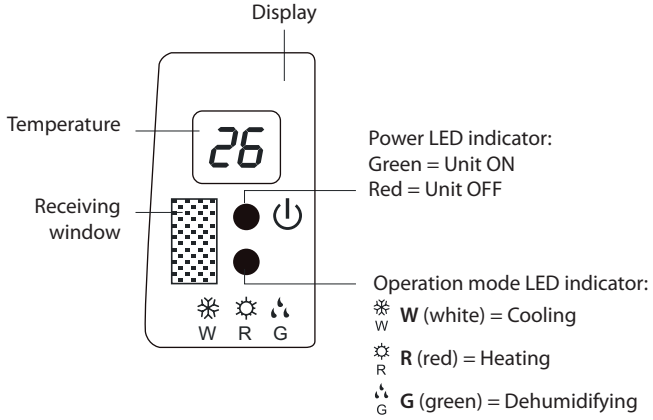

REMOTE CONTROL

BUTTONS ON REMOTE CONTROL

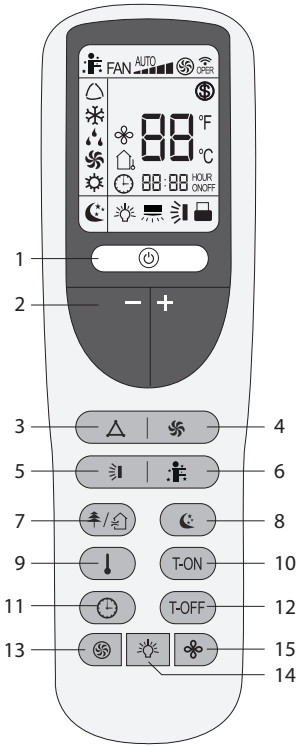

No.	Button	Function
1	ON/OFF	Turn on or turn off the unit
2	- / +	Set temperature and time
3	MODE	Set operation mode
4	FAN	Set fan speed
5	SWING	Set fan oscillating angle
6	I FEEL	Use of the remote control as ambient sensor
7	AIR	Not available on models presented in this manual
8	SLEEP	Lowering or raising the temperature gradually during the night
9	TEMP	Switch temperature displaying type
10	TIMER ON	Set starting time
11	CLOCK	Set up the clock
12	TIMER OFF	Set ending time
13	TURBO	Set turbo fan speed
14	LIGHT	Lighted display
15	X-FAN	Set autoclean

ICON IDENTIFICATION ON REMOTE CONTROL DISPLAY

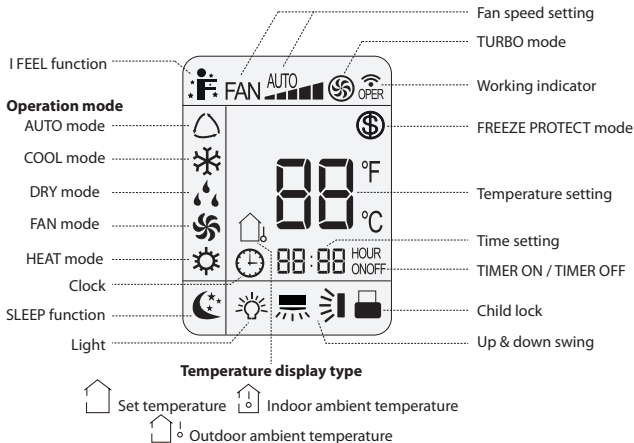

OPERATION OF REMOTE CONTROL

NOTES:

- This is a general remote control that could be used for multifunction appliances. If you push a button which is not featured on the model, the unit will continue to work as is.
- After powering it, the device will beep. Working indicator "⏻" is activated (in red). After that, you can operate the unit with the remote control.
- When you are using the remote control for the first time or after replacing batteries, set up the hour with the button CLOCK.
- In ON mode, when you push a button on the remote control, the icon "📶" blinks one time and device beeps to confirm that the signal has been sent to the appliance.
- In OFF mode, temperature and clock icons will be displayed on the remote control (if functions TIMER ON, TIMER OFF or LIGHT are activated, they will also be displayed). In ON mode, display will show icons of chosen functions.

1. ON/OFF button

Pushing this button allows to turn on or off the device.

Working indicator "⏻" on display of indoor unit will be green when device is turned on and will be red when it's turned off.

2. +/- button

Push "+" or "-" button to decrease or increase temperature by 1 °C at a time.

Temperature range is from 16 °C to 30 °C.

Maintain "+" or "-" button pushed for 2 seconds in order to change rapidly temperature. Once settings done, release button and temperature will be modified accordingly (temperature can't be settled in AUTO mode).

While adjusting TIMER ON, TIMER OFF or CLOCK, push "+" or "-" button to set the time. (Please see section CLOCK, TIMER ON, TIMER OFF buttons for more details.)

3. MODE button

Push this button in order to select operating mode of your choice:

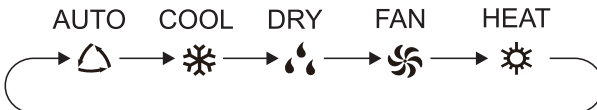

AUTO mode:

When you select automatic mode, the device automatically selects the appropriate function to maintain temperature between 20 °C and 25 °C. In this mode, temperature can't be changed or displayed on remote control. When turned on the first time, it works in AUTO mode by default.

COOL mode:

When you select COOL mode, the appliance is cooling the room. Press "+" or "-" to set temperature.

DRY mode:

When you select DRY mode, the appliance is in dehumidifying mode and works at its lowest speed. In this mode, the fan speed can't be changed..

FAN mode:

When you select FAN mode, only the fan is operating. There is no heating, nor cooling in this mode.

HEAT mode:

When you select HEAT mode, device is working on heating mode. Press the "+" or "-" button to adjust temperature.

NOTE:

- In HEAT mode, the device will delay start-up of the fan to prevent cool air to circulate. This delay can take up to 5 minutes depending on indoor air temperature.

4. FAN button

Push this button to select the fan speed along this sequence:

Automatic (AUTO), low (▲), medium (▲▲), high (▲▲▲).



NOTES:

- On AUTO speed, the device will choose ideal speed according to room temperature and set temperature.
- In DRY mode (dehumidification), fan always goes at low speed.

5. SWING button

Press this button to select oscillating angles for the louvres as per following sequence:

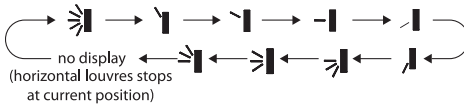

- When selecting "☀️", horizontal louvre will automatically flip upward and downward at a maximum angle.
- When selecting "↙", "↘", "↖", "↗", "↔️", the device blows air at fixed position. Horizontal louvre will stop to the chosen position.
- Hold the SWING button for 2 seconds to define required oscillating angle. When reached, release the button.

NOTES:

- "☀️", "↙", "↘", "↖", "↗" are not available on this unit. When device receives this signal, it will function as per following position "☀️".
- When the unit is turned off or when operation mode is changed, the louvre will return to the default position, either fixed up in cooling mode and fixed down in heating mode.

6. I FEEL button

Press this button to activate I FEEL function and the icon "  " will appear on remote control. Once this function is settled, remote control sends the information about room temperature to the control panel and will adjust automatically. Press again this button to cancel I FEEL function and the icon disappears.

Please put remote control near the user when this function is chosen. Do not put remote control near something at high or low temperature in order to prevent false results.

Make sure to keep the minimum distance recommended between the remote control and the appliance.

NOTE:

The remote control must point at the indoor unit receiving window at all time so that the control signal is received by the unit.

7. AIR button

This function is not available on models presented in this manual.

8. SLEEP button



SLEEP function is available in COOL (cooling), DRY (dehumidifier) and HEAT (heating) modes only. This function permits to gradually increase room temperature of 4 °C in COOL mode and to lower it in HEAT mode. You will then save energy without affecting your sleep. This function is settled over an 8-hour period. After this period of time, the device will work on previous established parameters, as it was set before SLEEP function was activated.

Press this button to activate SLEEP function and the icon "  " will appear on remote control. Press again this button to cancel SLEEP function and the icon disappears.

9. TEMP button

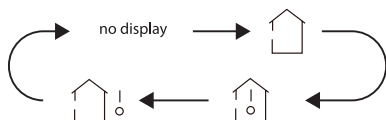
When pushing this button, you can choose the temperature you wish to see on the indoor unit display: set temperature, indoor room temperature or outdoor temperature.



- When "  " or "no display" is displayed, the set temperature is shown.
- When "  " is displayed, indoor room temperature is shown.
- When "  " is displayed, current outdoor temperature is shown.

NOTE:

Current outdoor temperature is not available on all models. In that case, the set temperature is shown.

10 and 12. TIMER ON button and TIMER OFF button

This timer function allows you to program the unit while determining when it starts and when it ends. Before using this function, make sure your unit is set on the right time.

Setting the starting time of the device:

1. Press TIMER ON button.
2. Press " + " or " - " button in order to set the starting time.
3. Press again TIMER ON to confirm time.

Icon " ON " appears and remote control shows current time.

Setting the ending time of the device:

1. Press the TIMER OFF button.
2. Press the " + " or " - " button in order to set the ending time.
3. Press again TIMER OFF to confirm time.

Icon " OFF " appears and remote control shows current time.

To cancel this function, press the TIMER ON and/or TIMER OFF button and corresponding icons will disappear.

NOTES:

- If only TIMER ON is set, the unit will work until you manually turn it off.
- If only TIMER OFF is set, the unit will not start again until you manually turn it on.

11. CLOCK button

Press this button to set time. Icon " ⌚ " on remote control will blink. Within the next 5 seconds, press button " + " or " - " to set time. With every push on the button " + " or " - ", time increases or decreases by one minute. Hold this either buttons for 2 seconds in order to change time faster. Press again the CLOCK button to confirm the hour and come back to normal display.

NOTE:

Clock uses 24-hour mode.

13. TURBO button

When TURBO function is on, the unit operates at super high speed to achieve quick cooling or heating.

This function is available only in COOL (cooling) or HEAT (heating) mode.

When you press this button, icon " ⚡ " appears on the screen. Press the button again to cancel TURBO function.

NOTE:

When TURBO function is activated, fan speed can't be changed.

14. LIGHT button

Press that button to light the indoor unit display screen. When the light on the display screen is on, icon " ✨ " appears on the screen.

15. X-FAN button

Pressing this button in COOL or DRY mode, the icon " 🌀 " is displayed and the indoor fan will continue operation for a few minutes in order to dry the indoor unit even though you have turned off the unit. After energization, X-FAN OFF is defaulted. X-FAN is not available in AUTO, FAN or HEAT mode. This function indicates that moisture on evaporator of indoor unit will be blown after the unit is stopped to avoid mould.

- Having set X-FAN function on: After turning off the unit by pressing ON/OFF button indoor fan will continue running for a few minutes at low speed. In this period, press X-FAN button to stop indoor fan directly.
- Having set X-FAN function off: After turning off the unit by pressing ON/OFF button, the complete unit will be off directly.

SPECIAL FUNCTIONS

Child lock function

This function eliminates unwanted temperature adjustments and the use of different modes on the device. Before activating it, make sure to have set the temperature as you like.

Press simultaneously "+" and "-" buttons to activate or deactivate the child lock function. When that function is activated, icon "🔒" is displayed on the remote control.

Temperature display in °C or °F

When device is turned off (OFF), press simultaneously on "-" and MODE buttons to switch from °C or °F.

FREEZE PROTECT mode

During winter, FREEZE PROTECT mode allows to maintain room temperature at 8 °C (46 °F) when you are not at home. When device is in HEAT (heating) mode, press simultaneously on CLOCK and TEMP buttons to activate this function. Icon "\$" will be displayed. Press again simultaneously on CLOCK and TEMP buttons to deactivate.

NOTES:

- In FREEZE PROTECT mode, fan speed is set by default to AUTO and cannot be adjusted.
- SLEEP and FREEZE PROTECT mode cannot be activated at the same time.

REPLACING BATTERIES IN REMOTE CONTROL

1. Lightly press the "☰" and slide in the direction the arrow is pointing to remove the back cover of the remote control (as illustrated).
2. Remove the old batteries (as illustrated).
3. Insert two new "AAA" (1.5 V) dry batteries and make sure the position of + and - is correct (as illustrated).
4. Put back the cover (as illustrated).

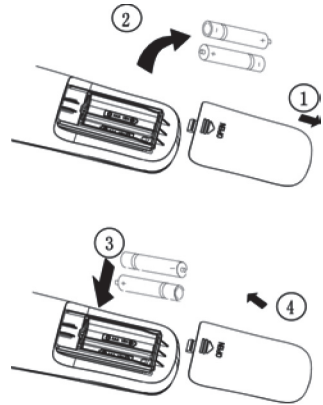

NOTES:

- During operation, point the remote control at the receiving window on the indoor unit.
- The distance between the remote control and receiving window should not be more than 26.25 ft. (8 m) and there should be no obstacle between them.
- The remote control should be placed 3.3 ft. (1 m) away from TV or Audio sets.
- The signal can be easily interfered in a room where there is a fluorescent lamp or wireless phone; the remote control should be near the indoor unit when operating.
- If the remote control does not operate normally, please take out the batteries and reinsert them after 30 seconds. If it is still not working, replace the batteries.
- When replacing batteries, use only new and identical ones (same brand).
- When you do not use the remote control for a long time, take out the batteries.

EMERGENCY OPERATION

If the remote control is lost or damaged, please use AUX button to turn on or turn off the appliance. As illustrated, open the panel, press the AUX button to turn on or turn off the device.

When it is turned on, it will operate under AUTO mode.

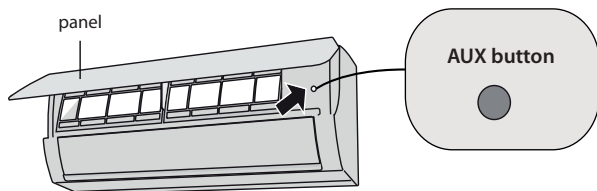

WARNING

Use insulated object other than metal to press the AUX button.

MAINTENANCE

CLEANING AND MAINTENANCE



WARNING

- Turn off the unit and disconnect the power before cleaning to avoid electric shock.
- Do not wash the unit with water to avoid electric shock.
- Do not use volatile liquid to clean the unit.

Cleaning the surface of indoor unit

When the surface of indoor unit is dirty, it is recommended to use a soft dry cloth or lightly moistened with water to wipe it.

NOTICE

Do not remove the panel when cleaning it.

Clean filter

1. Open panel

Open the panel into a certain angle as illustrated (less than 60°, do not force the panel).

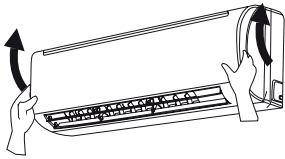

3. Clean filter

Use a vacuum or water to clean the filter. When the filter is very dirty, use water (below 45 °C) to clean it, and then put it in a shady and cool place to dry.

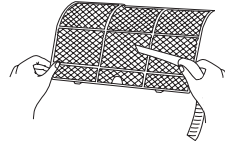

2. Remove filter

Remove the filter as illustrated.

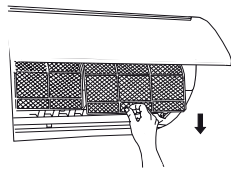

4. Install filter

Install the filter and then close the panel cover tightly.

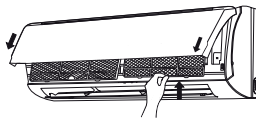

WARNING

- The filter should be cleaned every three months. If the unit operates in a highly dusty environment, cleaning frequency should be increased.
- After removing the filter, do not touch fins to avoid injury or damage the unit.
- Do not use fire or hair dryer to dry the filter to avoid deformation or fire hazard.

Checking before usage

1. Check that air inlets and air outlets are not blocked.
2. Check if circuit breaker and connection are in good condition.
3. Check that filters are clean.
4. Check that drainage pipe is not damaged or blocked.

Checking after usage

1. Disconnect power supply.
2. Clean filters and indoor unit panel.
3. Check whether mounting bracket for outdoor unit is damaged or corroded.
If so, please contact the dealer.

Notice for recovery

1. Many packing materials are recyclable. Please dispose of them in appropriate recycling bin.
2. If you want to get rid of the device, please contact a local recycling center for the correct disposal method.

MALFUNCTION

MALFUNCTION ANALYSIS

Please check below items before asking for servicing. If the malfunction still cannot be eliminated, please contact a qualified person.

Phenomenon	Items to check	Solution
Indoor unit cannot receive remote control signal or remote control does not work.	Is there severe interferences (such as static electricity, unstable voltage)?	Cut the power supply off and put the power back after about 3 minutes, and then turn on the unit again.
	Is the remote control within the signal receiving distance?	Signal receiving distance is 26.25 ft. (8 m).
	Is there any obstacle between the unit and the remote control?	Remove obstacles.
	Is the remote control pointing at the receiving window of the indoor unit?	Select proper angle and point the remote control at the receiving window on indoor unit.
	Is the remote control display fuzzy or there is no display at all ?	Check the batteries. If the battery charge level is too low, please replace them.
	No display when operating the remote control?	Check if remote control is damaged. If so, replace it.
	Are there fluorescent lamps in the room?	Bring the remote control close to the indoor unit. Turn off the fluorescent lamps and then try it again.
No air flow from indoor unit.	Are air inlet or air outlet of indoor unit blocked?	Eliminate obstacles.
	Under heating mode, has indoor temperature reached set temperature?	After reaching set temperature, indoor unit will stop blowing out air.
	Has the heating mode been just turned on?	In heating mode, in order to prevent blowing out cold air, indoor unit will start a few minutes after the unit has been turned on, which is normal.
Appliance cannot operate.	Is there a power failure?	Wait until power resumes.
	Circuit break trips off?	Ask a qualified person to replace circuit break or replace wiring.
	Has the unit been turned on immediately after being turned off?	Wait for 3 minutes, and then turn on the unit again.
	Are the function setting on the remote control correct?	Reset the functions
Indoor unit display screen doesn't work	Is the "LIGHT" function deactivated?	Press the "LIGHT" button on the remote control to light the indoor unit display screen.

Phenomenon	Items to check	Solution
Mist is emitted from indoor unit air outlet.	Are indoor temperature and humidity level high?	This is because indoor air is cooled rapidly. After a while, indoor temperature and humidity level will decrease and mist will disappear.
Set temperature cannot be adjusted.	Is the unit operating under AUTO mode?	Temperature cannot be adjusted under AUTO mode. Please switch the operation mode if you need to adjust temperature.
	Does your required temperature exceed the set temperature range?	Set temperature range: 16 °C to 30 °C (61 °F to 86 °F).
Air cooling (heating) is not efficient.	Is voltage too low?	Wait until the voltage comes back to normal.
	Is filter dirty?	Clean the filter.
	Is the set temperature in proper range?	Adjust temperature within proper range.
	Are doors and windows open?	Close doors and windows.
Odours are emitted.	Is there an odour source in the room, such as furniture or cigarette.	Eliminate the odour source.
	Is the heat exchanger dirty?	Have it cleaned by a specialist.
	Is the filter dirty?	Clean the filter.
Appliance suddenly operates abnormally.	There may be interferences, such as thunder, wireless devices, etc.	Cut the power supply off and put the power back. Then turn on the unit again.
Outdoor unit emits vapor.	Is the unit in heating mode?	During defrosting under heating mode, it may produce vapor, which is normal.
Water flowing noise.	Has the air conditioner just been turned on and off?	The noise is the sound of refrigerant flowing inside the unit, which is normal.
Cracking noise.	Has the air conditioner just been turned on and off?	This is the sound of friction caused by expansion and/or contraction of panel or other parts due to temperature changes.

ERROR CODES

When appliance status is abnormal, temperature indicator on indoor unit will blink and display corresponding error code. Please refer to list below for identification of error code.

Error code	What to do?
C5	Please contact a qualified person for service.
E2	Verify if filter needs to be cleaned. Make sure nothing is blocking air inlet or outlet. Restart device. If not, please contact a qualified person for service.
E5	It can be eliminated after restarting the unit. If not, please a qualified person for service.
E6	It can be eliminated after restarting the unit. If not, please contact a qualified person for service.
E7	Multizone heat pumps – There is a demand for cooling and heating at the same time. The indoor unit that sent the signal first has priority. The other indoor unit(s) are waiting for the end of the heating or cooling cycle, as the case may be, to enter the other mode.
E8	It can be eliminated after restarting the unit. If not, please contact a qualified person for service.
F0	It can be eliminated by disconnecting power at the main panel. Wait 10 minutes before energizing. If the error code remains, please contact a qualified person for service.
F1	Please contact a qualified person for service.
F2	Please contact a qualified person for service.
H1	This code indicates that device is in defrosting mode. When defrosting cycle is finished, code will disappear.
H6	It can be eliminated after restarting the unit. If not, please contact a qualified person for service.
U8	It can be eliminated after restarting the unit. If not, please contact a qualified person for service.

Note: If there are other error codes, please contact a qualified person for service.



WARNING

When below phenomenon occurs, please turn off the unit and disconnect power immediately, then contact a qualified person for service:

- There is an unusual sound during operation.
- Circuit break trips off frequently.
- Device generates a burning smell.
- Indoor unit is leaking.



CAUTION

- Do not repair or refit the appliance by yourself.
- If the appliance operates under abnormal conditions, it may damage the unit, cause electric shock or fire hazard.

PREPARATION BEFORE INSTALLATION

REQUIRED INSTALLATION CLEARANCE DISTANCES DIAGRAM

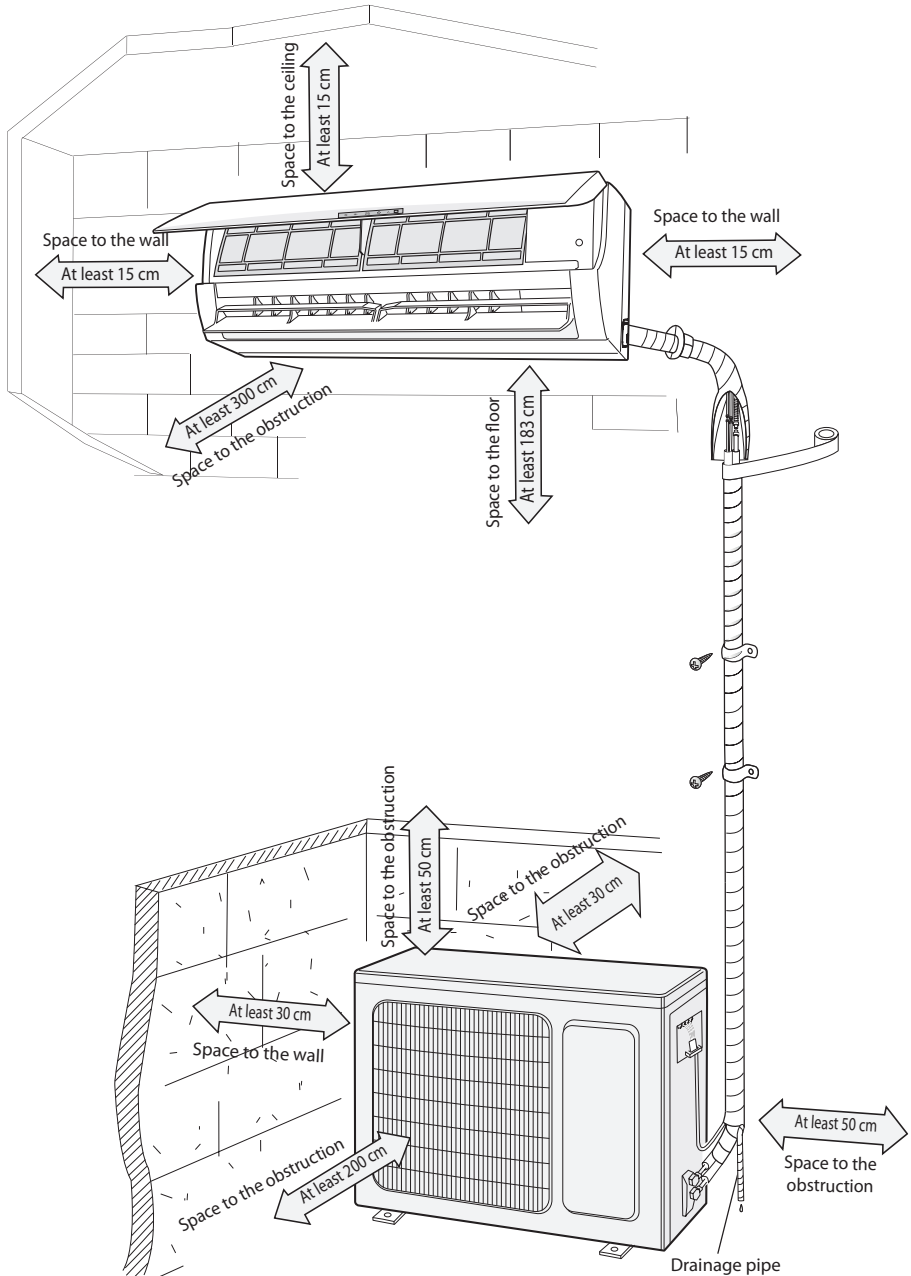

TOOLS REQUIRED FOR INSTALLATION

- Level meter
- Screwdrivers
- Impact drill
- Drill head
- Pipe expander
- Torque wrench
- Open-end wrench
- Pipe cutter
- Leakage detector
- Vacuum pump
- Manometer
- Multimeter
- Inner hexagon spanner
- Measuring tape

NOTICE

Contact a qualified person for installation.

SELECTION OF INSTALLATION LOCATION

Basic requirements

Installing the unit in the following places may cause malfunction. If it is unavoidable, please consult a qualified person:

- A place with strong heat sources, vapors, flammable or explosive gas or volatile objects spread in the air.
- A place with high-frequency devices (such as welding machine, medical equipment).
- A place near coastal regions.
- A place with oil or fumes in the air.
- A place with sulphurous gas.
- Other places with special environment.
- In a laundry room, near a bath, shower or swimming pool.

Indoor unit

- There should be no obstruction near air inlet and air outlet.
- Select a location where the condensation water can be dispersed easily and will not affect people.
- Select a location which is convenient to connect the outdoor unit and which is the closest possible to the power supply.
- Select a location which is out of reach for children.
- The location should be able to withstand the weight of indoor unit and will not increase noise and vibration.
- Make sure that the installation follows the requirement of clearance distance diagram.
- Do not install the indoor unit right above an electric appliance.
- Please try your best to keep the unit away from fluorescent lamps.

Outdoor unit

- Select a location where the noise and outflow air emitted by the outdoor unit will not affect neighborhood.
- The location should be well ventilated and dry, where the outdoor unit won't be exposed directly to sunlight or strong wind.
- The location should be able to withstand the weight of outdoor unit.
- Make sure that the installation follows the requirement of clearance distance diagram.
- Select a location which is out of reach for children and far away from animals or plants. If it is unavoidable, please add a fence for safety purpose.
- Do not install the outdoor unit opposite to an air outlet. Eg.: dryer outlet, kitchen hood, etc.

REQUIREMENTS FOR ELECTRICAL CONNECTION**Safety precautions**

- Must follow the electric safety regulations when installing the unit.
- According to the local safety regulations, use qualified power supply circuit and circuit break.
- Make sure the power supply matches with the requirement of the device. Unstable power supply or incorrect wiring may cause malfunction and damage the unit or fire hazard.
- Properly connect the live wire, neutral wire and grounding wire.
- Cut off the power supply before proceeding any work related to electricity.
- Do not put through the power before finishing installation.
- The temperature of refrigerant circuit will be high, please keep the interconnection cable away from the copper tube.
- The appliance shall be installed in accordance with national wiring regulations.

Grounding requirements

- The heat pump is a first class electric appliance. It must be properly grounded by a qualified person with specialized grounding device. Please make sure it is always grounded effectively, otherwise it may cause electric shock.
- The yellow-green wire in the appliance is the grounding wire, which cannot be used for other purposes.
- The grounding resistance should comply with national electric safety regulations.
- An all-pole disconnect switch having a contact separation of at least 3mm in all poles should be connected in fixed wiring.

INSTALLATION

INSTALLATION OF INDOOR UNIT

Step 1: Choosing installation location

- Recommend the installation location to the customer and then confirm it with the customer.

Step 2: Install wall-mounting frame

- Hang the wall-mounting frame on the wall; adjust it in horizontal position with the level meter and then point out the screw fixing holes on the wall.
- Drill the screw fixing holes on the wall with the impact drill (the drill head specification should be the same as the plastic anchor) and then put the plastic anchors in the holes.
- Fix the wall-mounting frame on the wall with tapping screws (ST4.2X25TA) and then check if the frame is firmly installed by pulling the frame. If a plastic anchor is loose, drill another fixing hole nearby.

Step 3: Open piping hole

- Choose the position of piping hole according to the direction of outlet pipe. The position of piping hole should be a little lower than the wall-mounting frame, as shown below.

12K

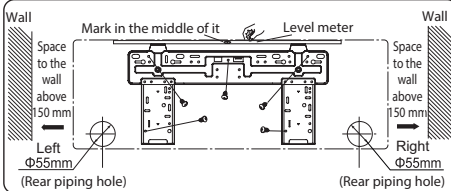

18K

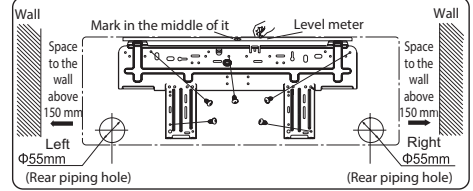

24K

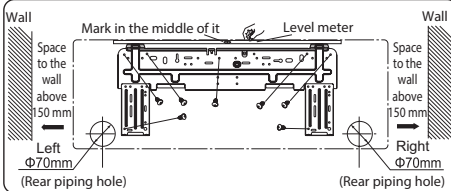

- Open a piping hole with a diameter of $\Phi 55\text{ mm}$ or $\Phi 70\text{ mm}$ depending on selected outlet pipe. In order to drain efficiently, slant the piping hole on the wall slightly downward to the outdoor side with a gradient of 5° to 10° .

NOTES:

- Pay attention to dust and take relevant safety measures when opening the hole.
- The plastic anchors are not provided and should be bought locally.

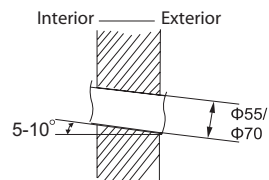

Step 4: Outlet pipe

- The pipe can be led out to the right, rear right, left or rear left.

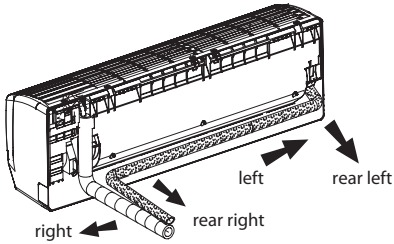

- When direction of the pipe has been selected, please cut off the corresponding hole on the bottom case.

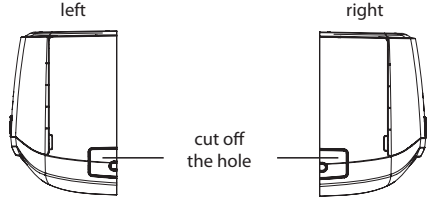

Step 5: Connect the pipe of indoor unit

- Aim the pipe joint at the corresponding bell mouth.
- Pre-tighten the union nut with hand.
- Place the open-end wrench on the pipe joint and place the torque wrench on the union nut. Tighten the union nut with torque wrench. Adjust the torque force by referring to the following table.

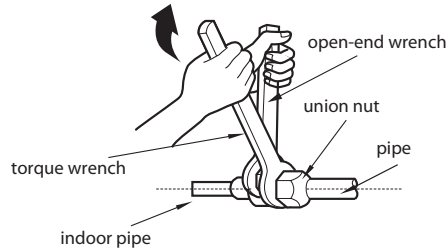
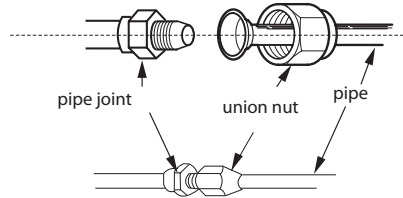

Hex nut diameter	Tightening torque (N·m)
Φ 6	15~20
Φ 9.52	30~40
Φ 12	45~55
Φ 16	60~65
Φ 19	70~75

- Wrap the indoor pipe and joint of connection pipe with insulating pipe, and then wrap it with tape.

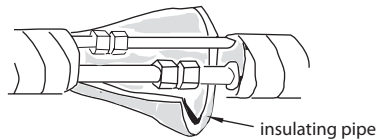

Step 6: Install drain hose

- Connect the drain hose to the outlet pipe of indoor unit.

- Bind the joint with tape.

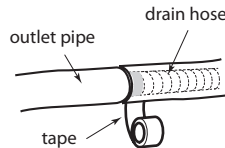
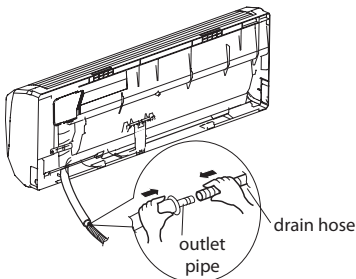

NOTICE

- Add insulating pipe around the indoor drain hose in order to prevent condensation.
- The plastic anchors are not provided.

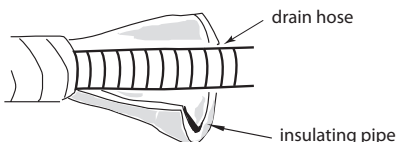

Step 7: Connect wire of indoor unit and repositioning of the ambient sensor

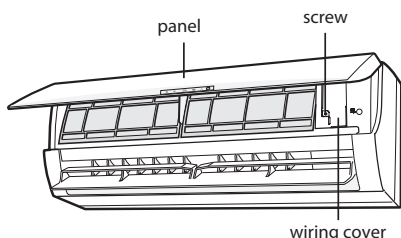

- Open the panel, remove the screw on the wiring cover and then take the cover off.

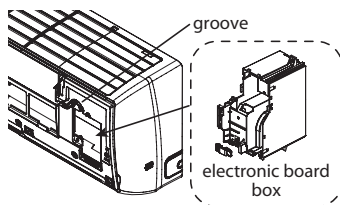

- Take the ambient temperature sensor in the electronic board box and insert it in the groove as per above image.

- Make the power connection wire go through the cable-cross hole at the back of indoor unit and then pull it out from the front side.

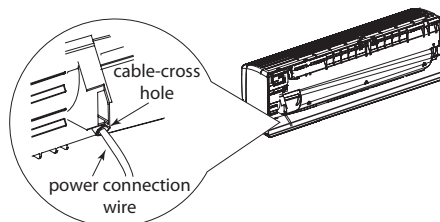

- Remove the wire clip; connect the power connection wire to the wiring terminal according to the color; tighten the screw and then fix the power connection wire with wire clip. After finishing wiring, clamp the grounding wire (yellow-green wire) into the wire-crossing groove as shown in the following figure, in order to avoid pressing the wire when closing the electric box cover.

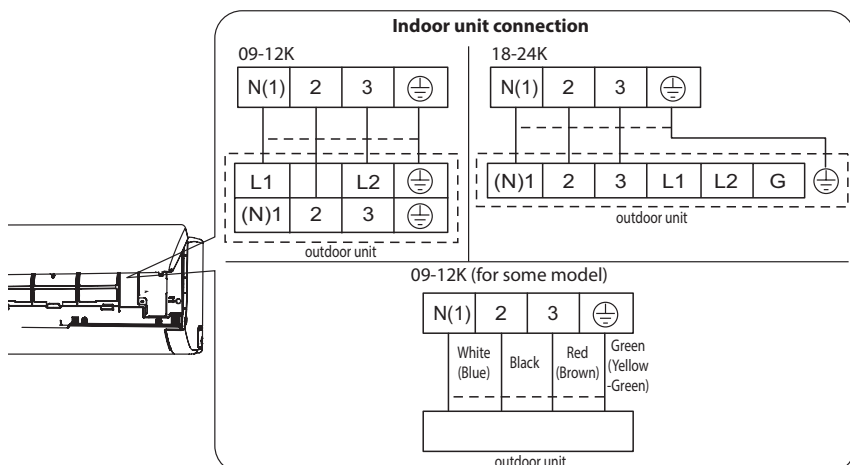

Note: this wiring diagram is for reference only, please always refer to the one on the actual unit.

- Put wiring cover back and then tighten the screw.

- Close the panel.

Notes:

- All wires of indoor and outdoor unit should be connected by a qualified person.
- If the length of power connection wire is insufficient, please contact your dealer for a new one. Do not extend the wire by yourself.
- A circuit break must be installed in the line. The air switch should be all-pole parting and the contact parting distance should be more than 3 mm.

Step 8: Bind up pipes

- Bind up the connection pipe, power cord and drain hose with the band.

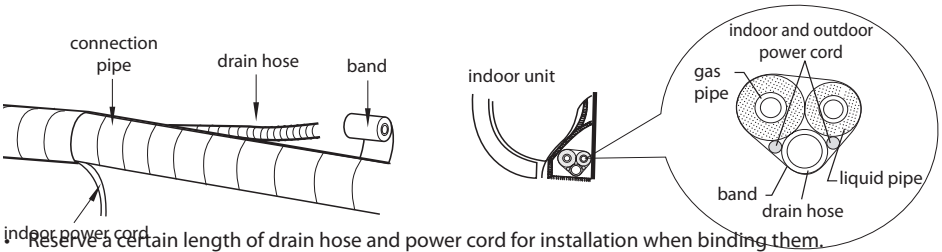

RESERVE A CERTAIN LENGTH OF DRAIN HOSE AND POWER CORD FOR INSTALLATION WHEN BINDING THEM.
 When binding to a certain degree, separate the indoor power and then separate the drain hose.

- Bind them evenly.
- The liquid pipe and gas pipe should be bound separately at the end.

Notes:

- The power cord and control wire cannot be crossed or winded.
- The drain hose should be bound at the bottom.

Step 9: Hang the indoor unit

- Put the bound pipes in the wall pipe and then make them pass through the wall hole.
- Hang the indoor unit on the wall-mounting frame.
- Stuff the gap between pipes and wall hole with sealing gum.
- Fix the wall pipe.
- Check if the indoor unit is installed firmly to the wall.

Note:

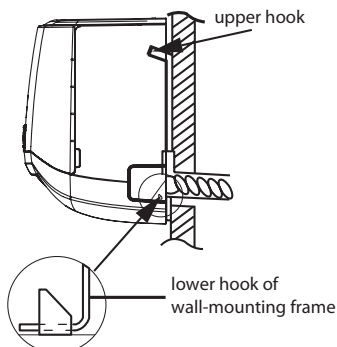
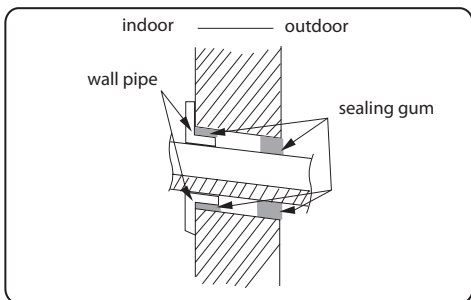

- Do not bend the drain hose excessively in order to prevent blocking.

INSTALLATION OF OUTDOOR UNIT

Step 1: Fix the support of outdoor unit (select it according to the actual installation situation)

- Select installation location according to the house structure.
- Fix the support of outdoor unit on the selected location with expansion screws.

Notes:

- Take sufficient protective measures when installing the outdoor unit.
- Make sure the support can withstand at least four times the unit weight.
- The outdoor unit should be installed at least 3 cm above the floor in order to install drain joint.
- Expansion screws needed per type of unit :

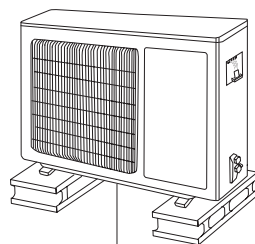

at least 3 cm above the floor

Cooling capacity BTU/hr (W)	No Number of screws
9000 (2637)	6
12000 (3516)	6
18000 (5274)	8
24000 (7032)	8

Step 2: Install drain joint

- Connect the outdoor drain joint into the hole on the chassis, as shown in the picture below.
- Connect the drain hose into the drain vent.

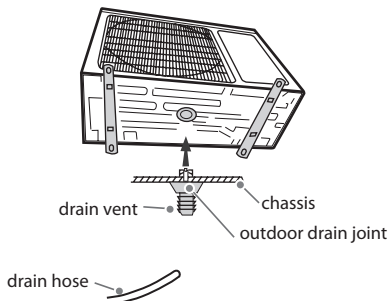

Step 3: Fix outdoor unit

- Place the outdoor unit on the support.
- Fix the foot holes of outdoor unit with bolts.

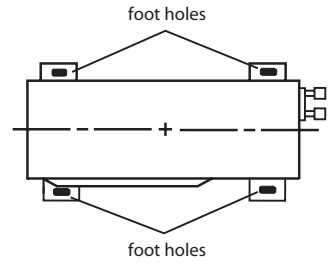

Step 4: Connect indoor and outdoor pipes

- Remove the screw on the right handle of outdoor unit and then remove the handle.

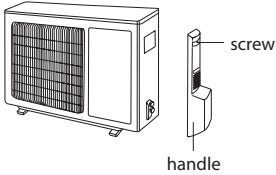

- Remove the valve cap and align the pipe joint on the flared orifice of the pipe.

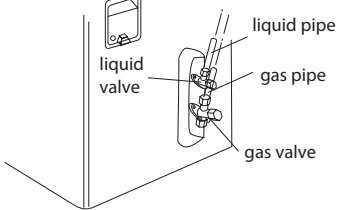

- Pre-tighten the union nut by hand.

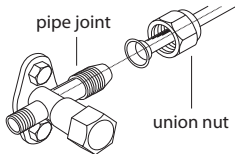

- Tighten the union nut with torque wrench by referring to the sheet below.

Hex nut diameter	Tightening torque (N-m)
Φ 6	15~20
Φ 9.52	30~40
Φ 12	45~55
Φ 16	60~65
Φ 19	70~75

Step 5: Wiring of the unit

- Remove the wire clip; connect the power connection wire and signal control wire to the wiring terminal according to the color; fix them with screws.

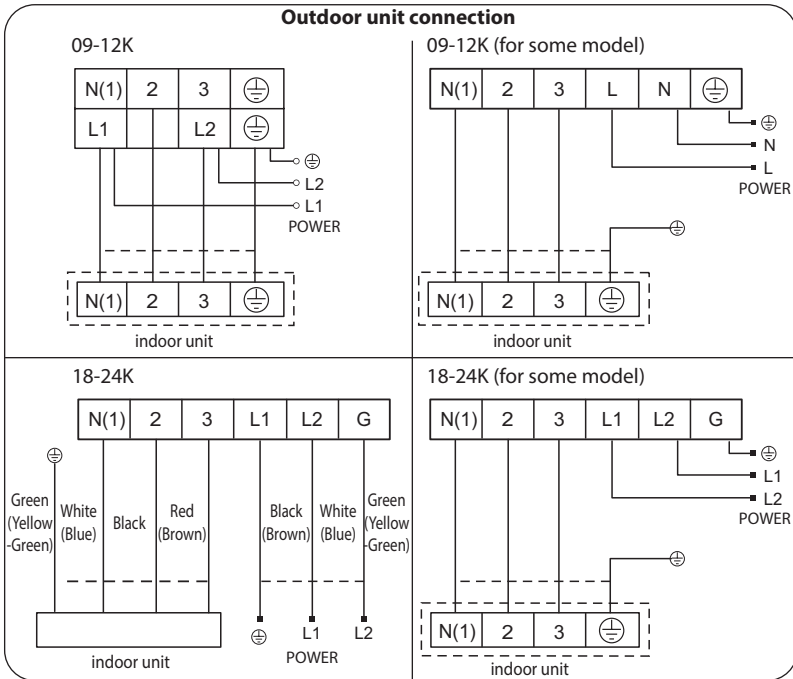

Note: this wiring diagram is for reference only, please always refer to the one on the actual unit.

- Fix the power connection wire and signal control wire with wire clip.

Notes:

- After tightening the screw, pull the power cord slightly to check if it is solid.
- Never cut the power connection wire to extend or shorten it.

Step 6: Pipe arrangement

- The pipes should be placed along the wall, slightly bent and if possible be hidden. The minimum bending semi diameter is 10 cm.
- If the outdoor unit is higher than the wall hole, you must set a U-shaped curve in the pipe before pipe goes into the house, in order to prevent rain from getting in.

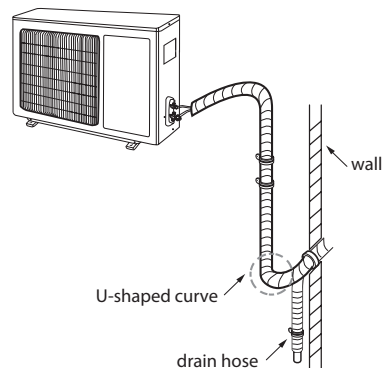

- The through-wall height of drain hose shouldn't be higher than the outlet pipe hole of indoor unit.

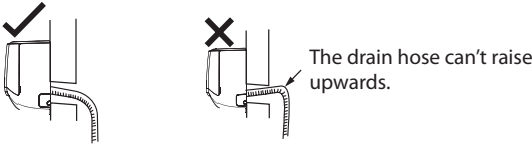

- For efficient drainage, the water outlet should not be submerged.

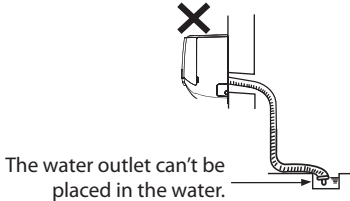

- Slant the drain hose slightly downwards; the drain hose can't be curved, raised, wavy, etc.

The drain hose must be straightened.

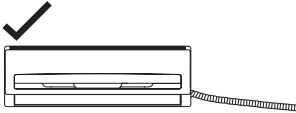

The drain hose can't be wavy.

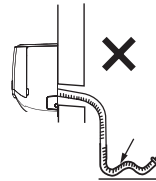
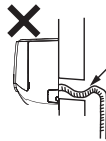
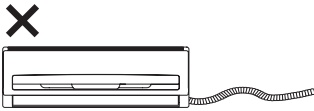

VACUUM PUMPING

- Remove the valve caps on the liquid valve and gas valve and the nut of refrigerant charging vent.
- Connect the manometer charging hose to the refrigerant charging vent of gas valve and then connect the other charging hose to the vacuum pump.
- Open the manometer completely and operate for 10 to 15 minutes to check if the pressure of manometer remains at -0.1 MPa.
- Close the vacuum pump and maintain this status for 1 to 2 minutes to check if the pressure remains at -0.1 MPa. If the pressure decreases, there may be leakage.
- Open the liquid valve and gas valve completely with inner hexagon spanner and remove the manometer.
- Tighten the screw caps of valves and refrigerant charging vent.

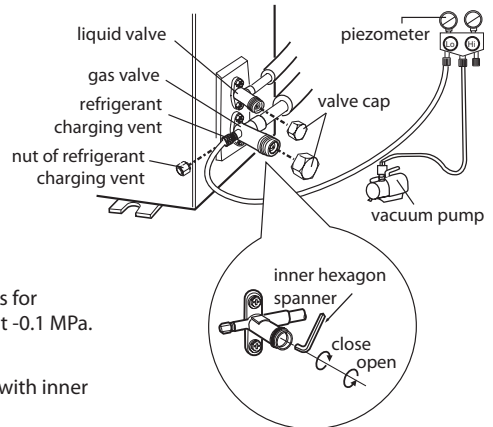

Note:

Using a micro gage, bring the vacuum value down to at least 500 microns and make sure the value remains stable for at least 10 minutes after the pump has stopped. If the value increase and doesn't stay below 500 microns, there is a leak in the system.

LEAKAGE DETECTION

- With a leakage detector, check if there is leakage.
- If leakage detector is not available, please use soapy water for leakage detection. Apply soapy water at the suspected position and leave it there for 3 minutes. If there are bubbles coming out of this position, there is a leak.

CHECKING AFTER INSTALLATION

Check the following items after finishing installation:

Items to check	Possible malfunction
Has the unit been installed solidly?	The unit may drop, shake or emit noise.
Have you done the refrigerant leakage test?	It may cause insufficient cooling (heating) capacity.
Is heat insulation of pipeline sufficient?	It may cause condensation and water dripping.
Is water drained well?	It may cause condensation and water dripping.
Is the voltage of power supply according to the voltage marked on the nameplate?	It may cause malfunction or damaging the parts.
Are electric wiring and pipes installed correctly?	It may cause malfunction or damaging the parts.
Is the unit grounded securely?	It may cause electric leakage.
Does the power wire follow the specifications?	It may cause malfunction or damaging the parts.
Is there any obstruction in the air inlet and outlet?	It may cause insufficient cooling (heating) capacity.
Are dust and installation debris removed?	It may cause malfunction or damaging the parts.
Are gas valve and liquid valve of connection pipe completely opened?	It may cause insufficient cooling (heating) capacity.

OPERATION TEST

1. Before operation test

- Ensure that the customer is satisfied.
- Inform the customers about the important notes of the appliance.

2. Operation test

- Put through the power, press the ON/OFF button on the remote control to start the unit.
- Press MODE button to select AUTO, COOL, DRY, FAN or HEAT to check whether the operation is normal or not.
- If the ambient temperature is lower than 16 °C, the appliance will not work in COOL (cooling) mode.

3. Operating pressure test

- In COOL or HEAT mode, set the temperature to the maximum set point (30 °C or 86 °F).
- Press the TURBO button to activate the fan TURBO speed.
- Wait until the compressor has reached its full speed (15 to 30 minutes).
- Once full speed is reached, take the operating pressure as well as indoor and outdoor temperature.
- Note your results in the table below and keep it for future reference.

Results of the operating pressure test	
Operating pressure	
Indoor temperature	
Outdoor temperature	

4. Other measures to consider

- Take the amperage reading with the unit in TURBO, HEAT and CAOOL mode. Wait until the amperage is stable before noting the results in the table below.

Tests	Results
Amperage reading in TURBO mode	
Amperage reading in HEAT mode	
Amperage reading in COOL mode	
Duration of the vacuum	
Vacuum value when stopping the pump	
Value 15 minutes after stopping the pump	
Reading of the micron gage	

OTHER CONSIDERATIONS

CONFIGURATION OF CONNECTION PIPE

- Standard length of connection pipe: 25 ft. (7.5 m).
- Minimum length of connection pipe: 10 ft. (3 m).
- Maximum length of connection pipe and maximum height difference:

Cooling capacity BTU/hr (W)	Maximum length of connection pipe ft. (m)	Maximum height difference ft. (m)
9000 (2637)	49 (15)	33 (10)
12000 (3516)	66 (20)	33 (10)
18000 (5274)	82 (25)	33 (10)
24000 (7032)	82 (25)	33 (10)

Additional refrigerant liquid and refrigerant charge required after extending connection pipes

- The calculation method of additional refrigerant charge (on the basis of liquid pipe) is:

Additional refrigerant charge (oz) = extended length of liquid pipe (ft.) x 0.2

- Based on the length of standard pipe and depending on pipe diameter, add refrigerant as per following chart.

Additional refrigerant charge for R410A

Diameter of connection pipe		Outdoor unit throttle	
Liquid pipe (mm)	Gas pipe (mm)	Cooling only (g/m)	Cooling and heating (g/m)
Φ 6	Φ 9.52 ou Φ 12	15	20
Φ 6 ou Φ 9.52	Φ 16 ou Φ 19	15	50
Φ 12	Φ 19 ou Φ 22.2	30	120
Φ 16	Φ 25.4 ou Φ 31.8	60	120
Φ 19	-	250	250
Φ 22.2	-	350	350

PIPE EXPANDING METHOD

Notes:

- Improper pipe expanding is the main cause of refrigerant leakage.
- Use mechanical joints only. Do not weld on the pipes.
- Please expand the pipe according to the following steps:

1. Cut the pipe

- Confirm the pipe length according to the distance between indoor and outdoor unit.
- Cut the pipe with pipe cutter.

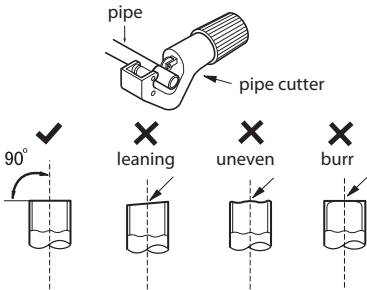

2. Remove the burrs

- Remove the burrs with a shaper and prevent the burrs from getting into the pipe.

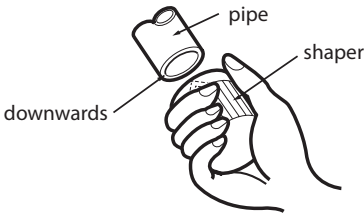

3. Put on suitable insulating pipe

4. Put on the union nut

- Remove the union nut on the indoor connection pipe and outdoor valve; install the union nut on the pipe.

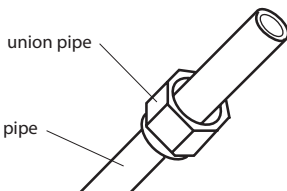

5. Expand the port

- Expand the port with an expander.

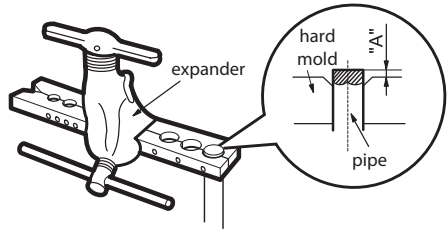

Note:

"A" varies according to the diameter, please refer to the chart below:

Outer diameter (mm)	A (mm)	
	Max	Min
Φ 6 - 6.35 (1/4")	1.3	0.7
Φ 9.52 (3/8")	1.6	1.0
Φ 12 - 12.7 (1/2")	1.8	1.0
Φ 15.8 - 16 (5/8")	2.4	2.2

6. Inspection

- Check the quality of the expansion. If the surface is not smooth, repeat the previous steps.

