

# INSTRUCTION MANUAL

INS506-201203-02

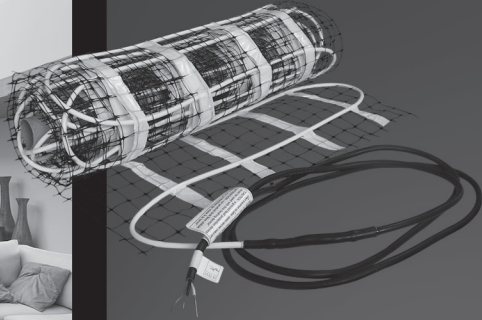

## OWC-M Series

Heating cable for concrete  
on mat



## OWC-R Series

Heating cable for concrete  
in reel

# Warranty

Subject to provisions stipulated in the Consumer Protection Act's legal requirements respecting the quality and durability of goods: Ouellet Canada Inc. guarantees its OWC series heating cables for a period of 20 years from the date of purchase against any manufacturing defect or malfunction.

## Limitations and exclusions

The above mentioned guarantees are limited to the reimbursement of the original purchase cost or replacement of the heating cables (hereinafter called "equipment") excluding any other part and also excluding any cost or any expense relating to connection, removal or installation of aforesaid equipment, including all workmanship costs. The buyer may choose between the reimbursement of the original purchase cost and the replacement of defective equipment, subject to the aforementioned restrictions. This warranty is provided to the original buyer of the equipment as well as subsequent owners of the building where the equipment was installed.

## Warranty terms

The above mentioned warranties are subject to the following conditions:

- i. The buyer must provide the original purchase invoice for the defective equipment, to Ouellet Canada Inc. or to one of their authorized dealer.
- ii. The buyer must report promptly in writing to Ouellet Canada Inc. any malfunction of equipment covered by the present warranties, in a reasonable time frame, from the time the malfunction occurred or the malfunction was brought to their knowledge thereby enabling Ouellet Canada Inc. representatives enough time to verify the defective equipment, if need be.
- iii. Equipment covered under the present warranties must be installed in compliance with Ouellet Canada Inc. instructions.
- iv. Equipment covered under the present warranties must be used under normal conditions of use and be maintained on a regular basis from the date of purchase.

## Name and address of the person providing the present warranties:



Ouellet Canada Inc.

180, 3<sup>e</sup> Avenue

L'Islet (Québec) G0R 2C0 CANADA

Telephone: 1 800 463-7043 or 418 247-3947

Fax: 1 800 662-7801 or 418 247-7801

info@ouellet.com

www.ouellet.com

# Table of contents

<b>1</b>	<b>Warnings and cautions</b>	<b>2</b>
<b>2</b>	<b>Product specifications and details</b>	<b>3</b>
<b>3</b>	<b>Approved installations</b>	<b>4</b>
<b>4</b>	<b>Critical information</b>	<b>5</b>
<b>5</b>	<b>Selection of the floor covering material</b>	<b>8</b>
<b>6</b>	<b>Thermal insulation</b>	<b>9</b>
<b>7</b>	<b>Installation instructions</b>	<b>10</b>
7.1	Room layout and corresponding floor heating system product	10
7.2	Work planning	11
7.3	Subfloor preparation	11
7.4	Identification of components	12
7.4.1	Installation of the cable on mat without reinforced concrete metal structure	12
7.4.2	Installation of the cable on mat with reinforced concrete metal structure	13
7.4.3	Installation of the cable in reel with reinforced concrete metal structure	14
7.5	Floor marking	15
7.6	First insulation and resistance test	15
7.7	Installation of the cold lead and electrical fault indicator	16
7.8	Installation of the heating cable	16
7.8.1	Installation of the heating cable on mat	16
7.8.2	Installation of the heating cable in reel	18
7.9	Installation of the temperature sensor	18
7.10	Final steps while securing the installation	19
7.11	Pouring the concrete slab or topping	19
7.12	Laying of the floor covering	21
<b>8</b>	<b>Electrical connection</b>	<b>22</b>
<b>9</b>	<b>Operation of the floor heating system</b>	<b>23</b>
<b>10</b>	<b>Control device</b>	<b>23</b>
<b>11</b>	<b>Operating tips</b>	<b>24</b>
<b>12</b>	<b>Locating fault</b>	<b>24</b>
<b>13</b>	<b>Control card</b>	<b>26</b>



## CAUTION!

*Please read through these instructions carefully before you begin installing & check that you are aware of all the components required.*

# 1 Warnings and cautions



## *Risks of electrical shocks and fire*



For safe installation and efficient performance of this system, read the instruction manual thoroughly and keep it handy.

- Where applicable, installation must meet requirements of the following codes:
  - Canadian Electrical Code (CSA C22.1 Part 1);
  - National Electrical Code (NFPA 70);
  - Any other applicable local and/or national code.
- Where required by law, this product must be installed by a qualified person.
- To prevent any possibility of electrical shocks, the power supply must be turned off before handling the heating cables.
- A GROUND FAULT PROTECTION DEVICE MUST BE USED WITH THIS PRODUCT, UNLESS EXEMPTED BY ELECTRICAL CODE IN FORCE.
- Heating cables must be used for indoor applications only.
- Heating cables must be installed and fully encased in concrete.

## SAVE THESE INSTRUCTIONS

## 2 Product specifications and details

The floor heating system is designed exclusively for interior floor heating. The system is not designed for snow melting or any other outdoor uses; it is mainly designed to complement a building's primary heating source by serving as a secondary (floor warming) or primary room heat source (radiant floor heating);

### **Heating Cable for Concrete on Mat:**

The floor heating system for concrete on mat is the assembly of a twin conductor heating cable attached to a plastic mat with 6" (15 cm) spacing between the cables. It is combined to an 8' 2" (2.5 m) cold lead.

### **Heating Cable for Concrete in Reel:**

The floor heating system for concrete in reel is made of a twin conductor heating cable combined to an 8' 2" (2.5 m) cold lead.

The heating cable consists of a resistance-heating element insulated with Fluoropolymer having high dielectric strength and high temperature withstand ability, which makes the heating cable safe. A metallic sheath provides additional mechanical strength and a ground path. A final PVC outer jacket makes it sturdier and provides corrosion protection. The hot and cold lead junction is uniquely designed to make it fool proof.

The heating cable for concrete is designed to generate 11 W/ft<sup>2</sup> (120 W/m<sup>2</sup>) with 6" (15 cm) spacing between the cables. Any spacing other than those specified in this manual must first be approved by the manufacturer.

The heating cables for concrete are available in a wide range of capacities and lengths to suit your requirements.

# 3 Approved installations

**Caution:** This product must be used with a ground fault circuit interrupter (GFCI) unless otherwise stipulated in the applicable electrical code.

The heating cable for concrete is approved for the following types of installation:

**Concrete topping of 1.5" (4 cm):**

- On subfloor.

**Important:** *The subfloor material in contact with the heating cable must be able to withstand a temperature of at least 90 °C (194 °F).*

**Concrete slab of 4" to 6" (10 cm to 15 cm):**

- On high density rigid insulation.

**Important:** *The rigid insulation in contact with the heating cable must be able to withstand a temperature of at least 70 °C (158 °F).*

- On reinforcing bars or wire mesh.

**Note:** *The floor heating system can be installed under a shower floor only if the floor is ceramic or natural stone. A waterproof membrane must be used to maintain the heating cables in a dry environment. The manufacturer recommends using a separate cable for the shower area. The CSA listing for this product covers use in wet locations for CANADA only. Wet location installation in United States shall be in accordance with the National Electric Code, (NFPA 70) and any other applicable jurisdictional code and final acceptance is to be made by the Authority Having Jurisdiction (AHJ).*

## 4 Critical information

- 1 **Heating cable must not touch, crossover or overlap itself** at any point. This could cause the cable to overheat.
- 2 **Heating cable cannot be cut or shorten.**
- 3 **The heating cable cannot be altered** in any circumstances. This may cause over heating resulting in damage to the cable.
- 4 The heating cable must be completely embedded in concrete.
- 5 **Take precautions to avoid damage to the heating cable** during installation and during concrete pouring.
- 6 **Heating cables should be separated from other heat sources** such as floor luminaries and chimneys.
- 7 **Do not install the heating cable below 5 °C (40 °F) ambient temperature.**
- 8 **Minimum bending radius** of the heating cable while laying shall not be less than 2.75" (70 mm).
- 9 Floor thermostat sensor location shall be centered between two adjacent runs of heating cable. Do not allow the cable to overlap any other cable.
- 10 **Check the main voltage and wattage** of the heating cable as per the selection made. These are indicated on the product name plate.
- 11 Keep the power leads conduit separated from the temperature sensor cable conduit.
- 12 Metallic structures or materials used for supporting cables or on which cables are installed must be grounded in compliance with the Canadian Electrical Code (CSA C22.1, section 10 and the National Electrical Code).
- 13 It is highly recommended to connect the **Cablecheck electrical fault indicator** at the free end of the cold lead during the installation to warn about accidental damage to the heating cable or lead wires.
- 14 In case GFCI trips during normal operation, and cannot be reset, there is likely a fault in the cable. No attempt should be made to re-energize the heating cable. **GFCI must not be bypassed in any circumstances.** Consult a qualified person.
- 15 **Do not install** the heating cable under permanent fixtures.
- 16 Allow sufficient drying or curing period of the subfloor and finished floor before and after installing the heating cable.
- 17 Indicate which branch circuits supply the power to the heating cable and retain the CSA labels for each heating cable in a convenient location, i.e. taped to the circuit breaker box, for reference by the electrical inspector or home owner. Leave one CSA label attached to the heating cable. Attach warning label in convenient location to show the room location where heating cable is installed.
- 18 Use only listed conduit, fittings, and other components.
- 19 Heating cables shall not extend beyond the room or area in which they originate.
- 20 This heating cable shall be installed only by a qualified person who is familiar with the construction and operation of the heating cable and the risks involved.
- 21 The installation of the heating cable shall be in accordance with the manufacturer's instructions and local national codes.
- 22 The manufacturer recommends using a separate cable for the shower area. It can be installed under a shower floor only if the floor is ceramic or natural stone. A waterproofing membrane must be used to maintain the heating cable in a dry environment. The CSA listing for this product does not cover use in wet location in the United States.
- 23 Use copper wires only.
- 24 The heating cable must not be installed in walls.
- 25 Install the temperature control where it is not accessible from the shower or bath (install at least 3' 4" (1 m) away).

## 26 Required distances and clearances

### CAUTION!

**NEVER install a heating cable under an interior wall or any fixed unit, a closet or in any other location where air cannot circulate freely over the floor surface. Always maintain the following minimum clearance:**

- 6" (15 cm) between heating cables;
- 3" (7.6 cm) between the mat strips (cable on mat only);
- 6" (15 cm) from any exterior wall, interior wall, drain, or any fixed obstacle you need to go around;  
**Note:** 10" (25.4 cm) from a toilet drain with wax ring seal.
- 3" (7.6 cm) from any fixed unit (e.g.: vanity sink, shower, refrigerator, etc.);
- 8" (20 cm) from any heating appliance affixed to or in contact with the floor;
- 1.5" (4 cm) between the heating cable and the concrete surface;
- 0.5" (1.3 cm) between the floor temperature sensor and the concrete surface;
- 0.5" (1.3 cm) between the heating cable and any exposed combustible surface;
- 2" (5 cm) between the floor surface and the furniture to allow air to circulate freely;
- 10' (3 m): maximum length of a free cable in a straight line.

**27** The system is only one step in the floor construction process. Each trade is responsible for the quality of its work and must ensure that the work performed by the previous tradesman has been duly completed according to code. All tradesmen are engaged in the installation process and share joint responsibility for it.

**28** Perform all six (6) insulation and resistance test steps required during installation:

- 1 Before breaking the security seal and opening the product.

**Note:** Once the seal is broken, you are then in charge of the cable integrity throughout the entire installation process. Be sure to follow instructions and observe all precautionary measures.

- 2 After the installation of the heating cable.
- 3 Before embedding the heating cable.
- 4 After embedding the heating cable.
- 5 After the final installation of flooring.
- 6 Before connecting the heating cable system.

- Enter results in the measurement table found in the envelope. All 6 measurements must be correctly recorded for the warranty to be applicable.
- Once completed, affix the measurement table to electrical panel and mark the specific circuit breaker that powers the heating cable circuit.

A qualified electrician must measure the system's insulation resistance as follows:

### Megohmmeter

- Use a calibrated megohmmeter only;
- Measure insulation resistance at the free end of the cold lead, between the phase conductors and ground;
- Write the reading in the measurement table;
- This reading must be over 1 000 000 ohms;
- If the reading is under 1 000 000 ohms, stop work and contact the manufacturer's technical support.

### Multimeter

- Use a calibrated multimeter only;
- Measure resistance at the free end of the cold lead, between the two phase conductors;
- Write the reading in the measurement table;
- Verify the heating cable integrity by comparing your reading to the value on the cold lead label;
- If your reading is very different from the nominal resistance at any step, stop work and contact the manufacturer's technical support.

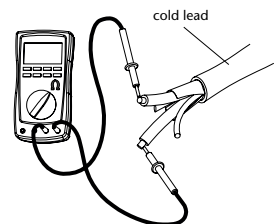
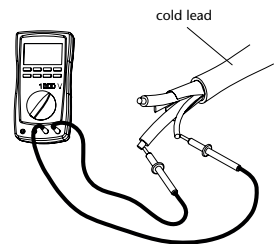

**CAUTION! Dangerous Test**



**WARNING!**

***"Risk of electric shock and fire".***

***"Damage to supply conductor insulation may occur if conductors are routed less than 3" (7.6 cm) from this heating product. Refer to installation instructions for recommended means of routing supply conductors".***



# 5 Selection of floor covering material

**Caution:** Check with the manufacturer to make sure your floor covering is compatible with the heating cable system.

The R-value of floor covering layers must not exceed the following values for the type of concrete used:

- R1.0 for concrete with a density of 106 lb./ft.<sup>3</sup> (1700 kg/m<sup>3</sup>) to 131 lb./ft.<sup>3</sup> (2100 kg/m<sup>3</sup>).
- R1.4 for concrete with a density of 131 lb./ft.<sup>3</sup> (2100 kg/m<sup>3</sup>) or higher.

There is no thermal insulation limit under the floor.

Typical floor covering	Thermal resistance	
	R	RSI
Vinyl tiles	0.20	0.035
Linoleum	0.22	0.039
Ceramic	0.25	0.044
Low-pile carpet	1.0	0.123
Natural stone (Granite, limestone, marble, sandstone) 1" thick	0.38-0.114	
Plywood 0.5" thick	0.63	
Parquet flooring	0.70	0.123
Floating floor 10 mm to 16 mm (3/8" to 5/8") (Laminate)	0.70	0.123
Wood on lathes (strapping)*	2.10	0.368

\*The floor covering highlighted in grey is prohibited.



## IMPORTANT!

***For engineered wood floorings, laminated hardwood flooring, vinyl coverings, and linoleum glued to a concrete surface, consult your floor covering manufacturer to ensure they are compatible with floor heating systems.***

# 6 Thermal insulation

The insulation levels of a floor will affect both the performance and running costs of the floor heating system.

The thermal insulation reflects the heat upwards into the floor instead of allowing heat to penetrate into the subfloor and keeps the floor warmer for a longer period of time. In cases where the floor heating system is being installed over large areas, insulation boards will greatly reduce warm-up times & running costs.

## IMPORTANT:

- **Concrete topping of 1.5" (4 cm):**

The subfloor material in contact with the heating cable must be able to withstand a temperature of at least 90 °C (194 °F).

- **Concrete slab of 4" to 6" (10 cm to 15 cm):**

The rigid insulation in contact with the heating cable must be able to withstand a temperature of at least 70 °C (158 °F).



## WARNING!

*Installation of a concrete heating cable system is not suitable for non-insulated or poorly insulated floors. The efficiency of this heating method hinges on specific conditions in order to provide acceptable performance levels, such as the dimensions of area to be covered with heating cables (or percentage of surface to be heated), floor coverings that can withstand the additional thermal heat, the quality of insulation of outer walls, etc. It is highly recommended to first examine certain parameters and seek advice from professionals before proceeding with the installation of this type of heating system.*

# 7 Installation instructions

## 7.1 Room layout and corresponding floor heating system product

Plan installation taking into account the guidelines below. We highly recommend planning the work process before the work begins to allow for the identification of obstacles to be bypassed, direction changes of the mat or cable, etc.

- Create a room layout plan to scale (for maximum accuracy, use the manufacturer form designed for this purpose);
- Identify all stationary elements (toilet, bath, shower, counters, dressers, and permanent furnishings) and never install the heating cable under these stationary elements (Figure 1);
- Determine thermostat or temperature control location;
- Indicate all the dimensions of the space that requires heating;
- Determine the electric cable (cold lead) location that will be connected to the heating control;
- Calculate the area to be heated using the following formula:  
(Length (ft) - 0.75) X (Width (ft) - 0.75)  
Then subtract the area covered by the stationary elements.
- Choose nearest suitable cable from the available range. When calculated size required is between two sizes of offered cables, select the smallest of the two. Combine multiple cables if necessary.

Room layout example

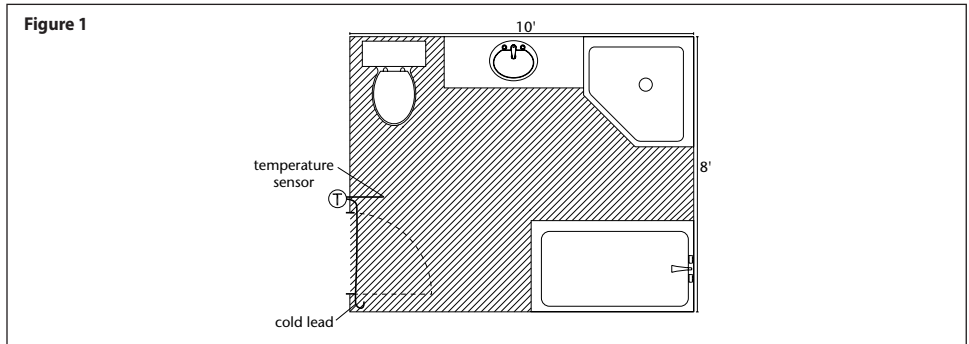

**Need help to optimize your work plan? Contact our technical support. Clearly indicate all dimensions. A minimum of one horizontal and one vertical dimensions are necessary to validate the scale.**

## 7.2 Work planning

### Materials provided by the manufacturer

- Heating cable
- Installation instructions
- Measurement table label
- Floor temperature sensor
  - Note:** Always use the temperature sensor supplied with the thermostat. The temperature sensor supplied with the heating cable is installed in case of failure of the thermostat sensor.
- Electrical fault indicator
- Plastic floor fasteners (cable on mat only)
- Plastic tie-wraps (cable in reel only)

### Material required

- Temperature control device (available at the manufacturer)
- Cable ducts for high voltage electrical cables (must be approved for high voltage electric cables (cold lead))
- Cable duct for temperature sensor (low voltage).
  - Note:** Cable ducts may be of the same type. However, it is important to make sure there are independent cable ducts for the cold lead and the temperature sensor.
- Safety glasses
- String roll
- Scissors
- Measuring tape
- Stapler
- Broom
- Felt marker (or spray)
- Adhesive tape
- Hammer
- Multimeter et megohmmeter
- Electrician tools

## 7.3 Subfloor preparation

### IMPORTANT:

#### Concrete topping of 1.5" (4 cm):

The subfloor material in contact with the heating cable must be able to withstand a temperature of at least 90 °C (194 °F).

#### Concrete slab of 4" to 6" (10 cm to 15 cm):

##### • Installation on high density rigid insulation:

The rigid insulation in contact with the heating cable must be able to withstand a temperature of at least 70 °C (158 °F).

##### • Installation on reinforcing bars or wire mesh:

Metallic reinforcement structure for reinforced concrete is required for the installation of concrete cables in reel. These cables are designed to be installed at a regular spacing of 6" (15 cm). It is therefore important to install a metallic reinforcement or wire mesh while adhering to this spacing. Any spacing other than those specified in the manual must first be approved by the manufacturer. Metallic reinforcement or wire mesh must be adequately supported with spacers or bricks at a recommended distance of 24" (60 cm) between supports. Wire mesh must be suitably overlapped and aligned and any sharp edge must be covered with adhesive tape (or other protective material).

**Note:** Please refer to the building code for recommendations pertaining to concrete subfloors.

## 7.4 Identification of components

### 7.4.1 Installation of the cable on mat without reinforced concrete metal structure

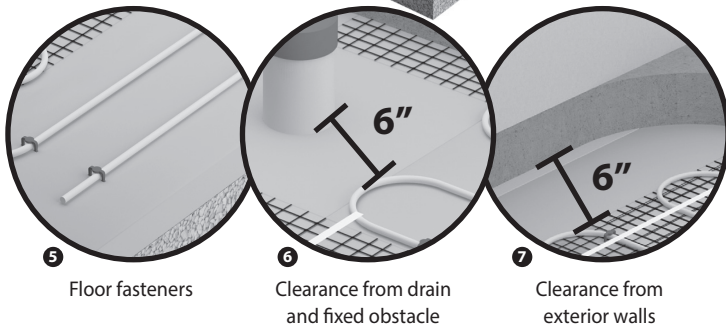
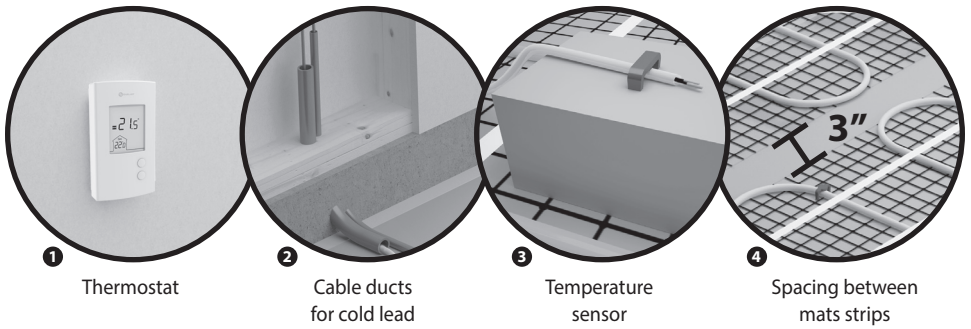

## 7.4.2 Installation of the cable on mat with reinforced concrete metal structure

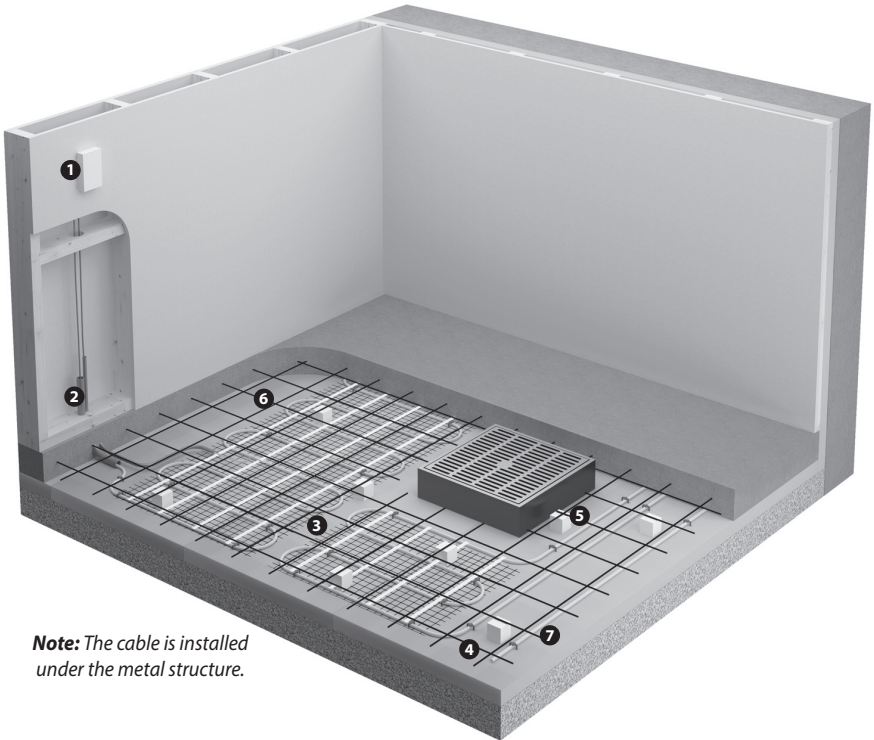
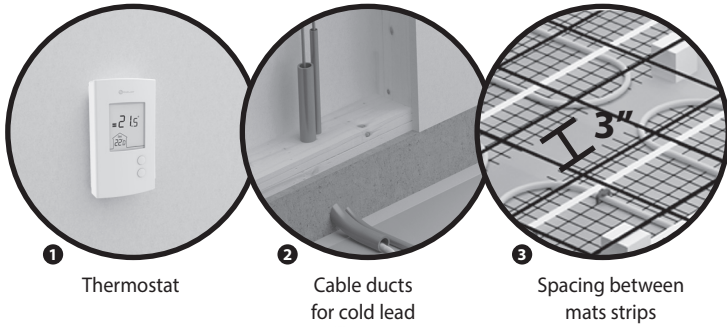

**Note:** The cable is installed under the metal structure.

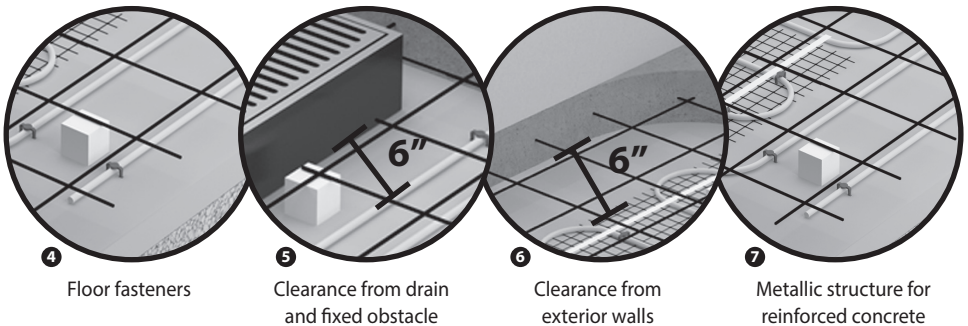

### 7.4.3 Installation of the cable in reel with reinforced concrete metal structure



1

Thermostat

2

Cable ducts  
for cold lead

3

Plastic  
tie-wraps

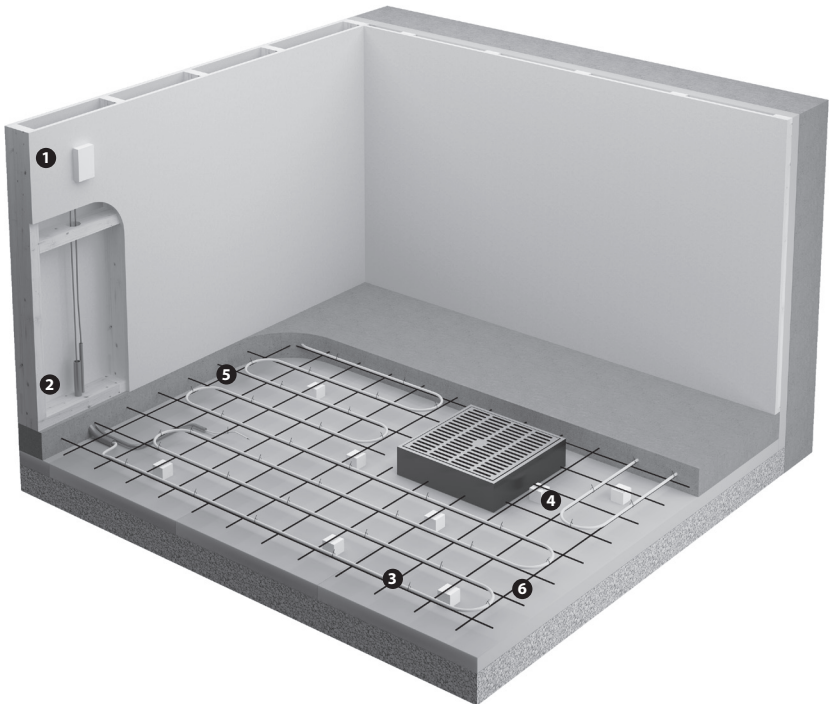

1

2

5

4

3

6



4

Clearance from drain  
and fixed obstacle

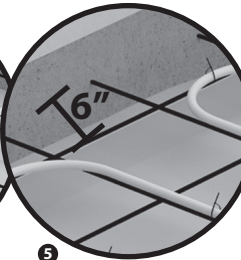

5

Clearance from  
exterior walls

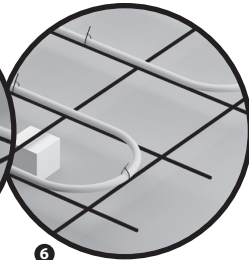

6

Metallic structure for  
reinforced concrete

## 7.5 Floor marking

- In an empty room (under construction or major renovations), with a marker or spray, draw on subfloor or metal structure the location of stationary elements (drains, walls, obstacles, etc.). These marks will outline the heating area to ensure the heating cable system is not placed too close or under these stationary elements (image 1).
- Identify the starting point for the concrete heating cable and the space required for the installation of the cold lead duct.
- Identify the location of the temperature sensor and temperature control device.

**Note:** The floor temperature sensor must be centered between two parallel heating cables. The ideal location is one where it is likely to be away from stationary objects and sheltered from outside influences (sunlight) that could skew floor temperature readings. For maximum comfort, the area above the sensor must be free of obstruction.



## 7.6 First insulation and resistance test



### 1) First insulation and resistance test.

Before breaking the security seal and opening the product, measure the cable's electrical and insulation resistance and record the readings on line 1) Before breaking seal.

**Note:** Once the seal is broken, you are then in charge of the cable integrity throughout the entire installation process.

## 7.7 Installation of the cold lead and electrical fault indicator

- 1 Install the cable duct for the cold lead at the pre-determined location, (where the cable will be unrolled).
- 2 Feed the cold lead into the cable duct making sure the mechanical connection between the cold lead and the heating cable remains outside the cable duct by at least 12" (30 cm). There should be no part of the heating cable found near the cable duct (image 2).

### ATTENTION!

**There should be no part of the heating cable found near the cable duct or inside the wall.**

- 3 Install the electrical fault indicator in compliance with the instructions, at the end of the cold lead.

4 Hang the cold lead and electrical fault indicator, using string or a hook, from one of the ceiling joists or other element so it is handy but make sure it doesn't obstruct the installation process (image 4).

**Note:** Make sure the cold lead is long enough to reach the thermostat or junction box.

5 Switch the electric fault indicator on.

**Note:** If the electrical fault indicator sounds during installation, immediately postpone the heating cable installation and contact our technical support.



Image 2



Image 3



Image 4

## 7.8 Installation of the heating cable

### 7.8.1 Installation of the heating cable on mat

- Unroll the mat on the subfloor while adhering to the required clearances.
- On high density rigid insulation, use supplied plastic fasteners to anchor the cable on the subfloor (images 5 and 6).
- On a plywood subfloor, staple the mat.



**IMPORTANT!**

**Never staple the heating cable directly to the subfloor.**

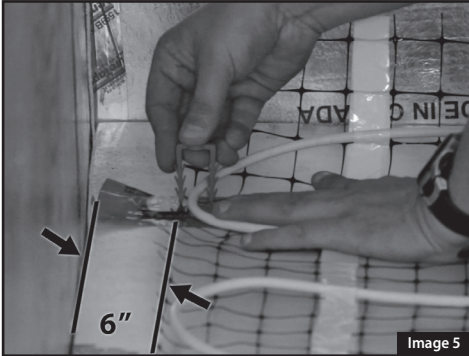

Image 5



Image 6

**Note:** It is recommended to simply secure the ends of the cable or mesh while first unrolling the cable (in the event of errors or modification of boundaries) and to anchor the cables more firmly thereafter when the process is complete (step 7.10).

- Upon encountering walls, simply cut the mat and rotate it in another direction. Use scissors to cut the mat, being very careful not to damage the cable and use the floor fasteners or stapler to secure both extremities of the mat onto the subfloor (Figure 2).
- Upon encountering any obstacle or fixed element to be bypassed, simply cut the mat and remove the cable over a certain length so as to easily be able to bypass the obstacle. Use scissors to cut the mat, being very careful not to damage the cable and use the floor fasteners or stapler to secure both extremities of the mat onto the subfloor (Figure 2).

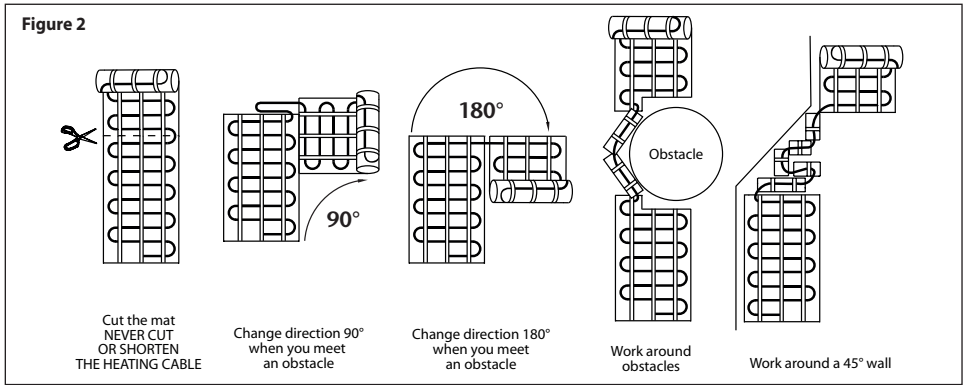

- When two adjacent rooms are heated by the heating cable, it is recommended to cover the traffic area between these rooms to avoid cold spots. To do so, simply cut the mesh and remove the cable from the mesh over a certain length to cover the traffic area (Figure 3). Use scissors to cut the mat, being very careful not to damage the cable and use the floor fasteners or stapler to secure both extremities of the mat onto the subfloor.

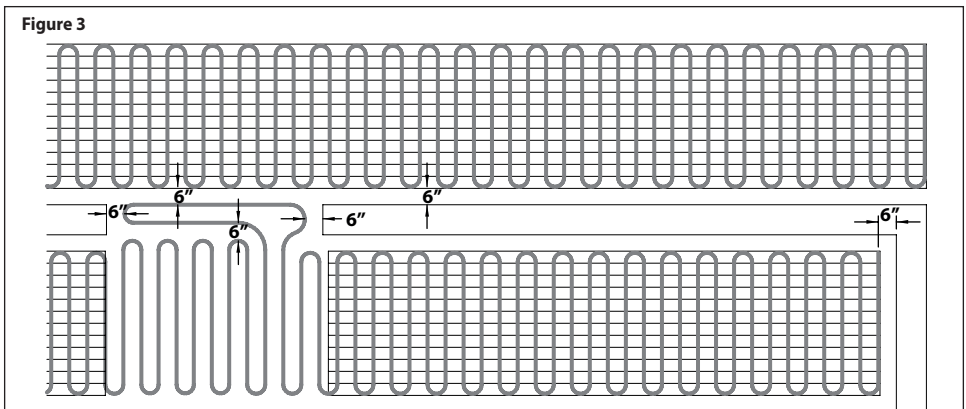

**Note:** It is possible to use adhesive tape ('tuck' tape) to secure the mat or cable onto the subfloor. However, we recommend using the fasteners supplied with the kit to ensure a sturdy installation.





## WARNING!

- **Never attempt to cut or shorten a heating cable.**
- **Be very careful while maneuvering onto the heating cables.**
- **It is important not to subject heating cables to any kind of mechanical stress (stretching, bend radius less than 2.75" (70 mm), notches).**

### 7.8.2 Installation of the heating cable in reel

Unroll the cable, adhering to the required clearances and anchor cables onto the metallic reinforcement structure using the supplied plastic tie-wraps.

**Note:** It is recommended to simply secure the ends of the cable while first unrolling the cable (in the event of errors or modification of boundaries) and to anchor the cable more firmly thereafter when the process is complete (step 7.10). Although the concrete cable is very rugged, you must be careful not to damage the cable while circulating on the metallic reinforcement structure.

## CAUTION!

**Never exceed the maximum allowed length of 10' (3 m) for a free cable in a straight line.**

### 7.9 Installation of the temperature sensor

- Once the cable is installed, install the cable duct for the temperature sensor at the pre-determined location.  
**Note:** The ideal location is one where it is likely to be away from stationary objects and sheltered from outside influences (sunlight) that could skew floor temperature readings. For maximum comfort, the area above the sensor must be free of obstruction.
- Feed the temperature sensor into the appropriate cable duct and locate it between two parallel heating cables.  
**Note:**
  - It is recommended to install two (2) temperature sensors; in case of malfunction of the first one, the second sensor is already encased and ready for connection.
  - Always use the temperature sensor supplied with the temperature control as your primary sensor. The one supplied with the heating cable should be used as back up.
- The temperature sensor must be installed at 0.5" (1.3 cm) from the floor surface and solidly anchored on a piece of wood or polystyrene foam so it will not move during the concrete pouring process (images 8 and 9).  
**Note:** Make sure the sensor is long enough to be connected to the thermostat.

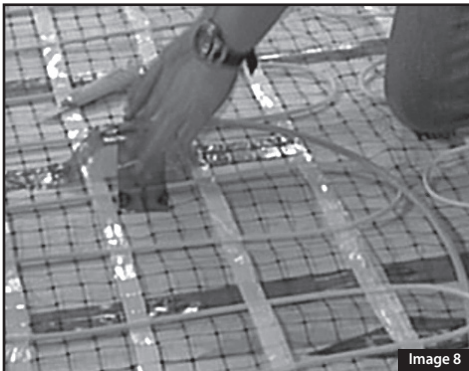

Image 8



Image 9



## WARNING!

**The temperature sensor must be completely encased in concrete.**

## 7.10 Final steps while securing the installation

- Once the installation of the cable and sensor is complete, you must then secure the entire installation.

### Cable on mat

- On high density rigid insulation, add plastic floor fasteners on the heating cable and temperature sensor. A sufficient quantity of fasteners is supplied with the kit to ensure the installation of one (1) fastener at every feet (30.5 cm) of mat.
- On a plywood subfloor, secure the mat with staples (not supplied).

**Note:** We recommend securing the beginning and end of every mat section with 4 fasteners and then allocating the rest of the fasteners at every 2' (61 cm) maximum over the entire installation.

### Cable in reel

Secure the installation by adding plastic tie-wraps on the heating cable and the temperature sensor (images 10 and 11). A sufficient quantity of tie-wraps is supplied with the kit to ensure the installation of one (1) fastener at every 6" (15 cm) of cable.



Image 10



Image 11

- Once the installation is secured, prepare the material required for the protection of the cable in accordance with the concrete pouring method selected. See section 7.11.



### 2) Second insulation and resistance test.

After the installation of the heating cable, measure the cable's electrical and insulation resistance and record the readings on line 2) After cable installation.

## 7.11 Pouring the concrete slab or topping



### 3) Third insulation and resistance test

Before encasing the heating cable in concrete, measure the cable's electrical and insulation resistance and record the readings on line 3) Before embedding the cable.

- Switch the electrical fault indicator on BEFORE any circulation on the cable and BEFORE the concrete pouring process begins (image 12).



Image 12

**ATTENTION!**

*If the electrical fault indicator rings during the pouring process, mark the location where the cable was damaged using a stake. Delineate an area at least 2 ft<sup>2</sup> (0.18 m<sup>2</sup>) around the location where the cable was damaged and **DO NOT COVER** that area with concrete. Finish the concreting process and call our technical support for a concrete cable repair kit.*

- 2 Install the material required for the protection of the heating cables during the concreting process.

**Concreting process using a concrete pump:**

- Pay special attention when moving around the mat so as not to damage the cables.
- Always place pieces of plywood or polystyrene foam underneath the pump hose, more specifically, under the joints and connections to ensure they do not come into contact with the heating cables.
- Once the pump is activated and the concrete is pouring, always lift the end of the hose to ensure it does not come into contact with the heating cable.

**Concreting process using a wheelbarrow:**

- Pay special attention when moving around the mat so as not to damage the cables.
- Protect the heating cable installation with a piece of plywood while moving the wheelbarrow around.
- It is important to install a plywood panel underneath the wheelbarrow before pouring any concrete so the wheelbarrow buffer does not come into contact or damage the heating cables.
- Avoid using the same trajectory with the wheelbarrow. This will allocate stresses throughout the entire installation.



Image 13

- 3 The heating cable system must be encased with a minimum of 1.5" (4 cm) or 4" to 6" (10 to 15 cm) of concrete, depending on the type of installation.

**Note:** *It is imperative that the ENTIRE heating cable installation be encased in concrete. There should be no jutting parts or heating cable visible.*

- 4 If using a metallic structure for reinforced concrete, pay special attention to the cable while moving around the reinforcement structure. Make sure enough wedges or bricks have been used to ensure the structure can withstand any shifting as well as the weight of the concrete, without varying in height. Be careful not to catch any of the cables with the tools.

- 5 Level the concrete in a normal fashion paying special attention not to catch any of the cable ducts used for the cold lead or temperature sensor (images 14 and 15).



- 4) Forth insulation and resistance test.

Once the concrete has been applied, measure the cable's electrical resistance and record the readings on line 4)

4) After embedding the cable.

## 7.12 Laying of the floor covering

- Consult the manufacturer instructions of the chosen floor covering. Consult section 5 of the present manual for the selection of the floor covering material.



- 5) Fifth insulation and resistance test.

After final surfacing. Once the concrete has been applied and completely dried, measure the cable's electrical resistance and record the readings on line 5) After final surfacing.

# 8 Electrical connection



## WARNING!

*Electrical connection must be performed by a master electrician, only after the cable has been installed and encased in concrete and the curing of concrete period is complete.*

**WARNING! DANGER OF ELECTROCUTION:** *always make sure the power supply circuit is turned off before proceeding with the electrical connection.*



### 6) Sixth insulation and resistance test.

Before wiring the system, measure the cable's electrical resistance and record the readings on line 6) Before wiring the system.

- 1 Perform the connection in compliance with instructions provided with the temperature controller and in compliance with local and national electrical specifications in effect.

### Cold lead

240V/208V and 347V connection:

Line 1 – Black

Line 2 – Red

Ground – Yellow/Green

### IMPORTANT

- Check product name plate to make sure that voltage supply is correct.
- Never connect a 208/240V product at 347V or vice versa.

- 2 The master electrician who installed and connected the floor heating system must complete the measurement table (this label is available at the opening of the product) and give it to the customer. This label must be kept on the electrical panel.



## CAUTION!

***If the table is not duly completed, the warranty may be void.  
Warranty terms are set on the back of the cover page.***

## 9 Operation of the floor heating system

The floor heating system is now ready for use. However, before turning on the system, make sure the curing period specified by the concrete manufacturer has expired. Adjust the thermostat's temperature based on your needs and desired comfort level.

## 10 Control device

### Important

The floor heating system must be controlled by a temperature control system.

An electronic floor temperature control featuring a floor sensor is recommended to ensure heat levels never exceed the floor covering maximum temperature tolerance.

The room temperature control and floor temperature sensor must never be installed where they will be exposed to sunlight or air drafts.

#### *Recommended temperature regulation devices:*



#### **IMPORTANT!**

**1 Thermostat with floor sensor and integrated GFCI (floor warming only).**

**2 Electronic ambient thermostat with a GFCI (radiant room heating).**

For installations requiring more than one electrical circuit, get a set of adequate controls including a master thermostat and the required number of slave units, according to the total power of the system.

For models of 3700W and more, the installation requires a relay with low voltage thermostat.

We recommend using a thermostat with floor sensor specially designed for the control of floor heating systems.

The floor sensor comes with a lead wire/cable of 15' (4.6 m) length.

The floor sensor location shall be centered between two adjacent runs of heating cable.

Sensor cable shall be routed to the thermostat located in the wall at suitable operating height.

Do not allow any other cable to overlap with the sensor cable.

The details of thermostat installation will be available in the instruction manual provided with the thermostat.

**\*\*\*Refer to instructions that came with your specific thermostat for electrical schematics\*\*\***

# 11 Operating tips

- 1 When first energized, the heating cables may take sometime to fully warm your floor.
- 2 Energy consumption will vary depending on user preferences.
- 3 Energy consumption can be minimized by turning the system OFF when floor heat is not required, but you will have to allow time for the floor to warm up once the system is turned ON again.
- 4 Do not place thick mats/rugs/floor level furniture/mattresses on your heated floor. These restrict the heat transfer and may result in the cable overheating.
- 5 Avoid mats with rubber or vinyl type backing, as these may decompose with heat and could stain flooring.

# 12 Locating fault

If the cable gets damaged during installation, the **Cablecheck** electrical fault indicator (sold separately) will warn you about the damage.

## Electrical fault finding

Once the system has been turned off and made safe, have a qualified person:

- 1 Ensure all wires have been connected as per the wiring diagrams;
- 2 Make sure multiple rolls have been wired in parallel and not in series;
- 3 Confirm that control devices are receiving correct voltage.

Using a well calibrated multimeter with good batteries, or preferably, a digital multimeter, the ohm resistance level of each heating cable should be checked and the reading compared with the resistance that was recorded during installation and the nominal value indicated on the corresponding CSA label.

If your reading is not within the original reading range, the cable may have been damaged in some way.

This indicates an open or short circuit beneath the finished flooring. The qualified individual must locate the point of break or short.

At all time, turn off the power at the main panel and disconnect the heating cable from the thermostat to take readings.

## Locating a break or a short

If your installation is complete, all wiring connections have been verified to be correct, including grounding of the system, you have checked the sensor wire for proper Ohms reading, and you suspect the system is still not working; you need to determine if there is a break or a short under the floor.



**WARNING!**

### ***Danger of electrocution.***

- ***Always make sure the power supply circuit is turned off at the panel before proceeding with tests.***
- ***Always disconnect the heating cable from the controller to take reading.***

### Checking for breaks

The ohm resistance of each cable should be measured. Make sure the probes of the multimeter do not touch the ground wire of the power connector. Make sure you do not touch either of the probe ends, or the meter will be reading your internal body resistance.

Make sure your multimeter is set on the proper scale (0 to 2000Ω for heating cable, or 0 to 20,000Ω for the floor temperature sensor wire).

Your ohm resistance readings should be within +10%/-5% of the nominal resistance indicated by the factory on the CSA label.

If your ohm reading is within +10% / -5% of what it should be, there is no break. However you still need to check for an electrical short.

If your ohm reading is lower (outside the range), but there is clearly some continuity, check your multimeter and your batteries. If these are good, there is a possibility that you have several electrical shorts.

If you have absolutely no reading (infinity on your meter), and you are sure you adjusted the setting of the multimeter to the correct reading range (0 to 2000Ω for the heating cable, or 0 to 20,000 Ω for the floor temperature sensor wire), then you have a break (total cut) in the conductor.

### Checking for electrical short:

In some rare occasions an installation may have suffered from a high pressure point that broke the insulation between the core conductor and the metal sheath. Such opening in the insulation layer can create an electrical short, even though the Ohm reading from the line conductor to the other line conductor is normal and does not indicate any circuit break. In these rare occasions a continuity test will show continuity between the line conductor and the ground wire, and/or between the other line core conductor and the ground.

There should be no continuity ("infinite" resistance reading, not zero) between the line conductor and the ground.

There should be no continuity ("infinite" resistance reading, not zero) between the other line conductor and the ground.

If your instrument reveals continuity between both the line conductors and the ground, there is a short in the circuit.

There are three ways to locate breaks or electrical shorts with underground fault detectors:

- 1 A break can be found with a "thumper", an impulse-generating device that generates a sound at the break point. The thumper includes a stethoscope to locate the exact placement of the break under the floor.
- 2 A short can be found with a "time domain reflectometer" tester, which will measure the distance of the wire between the tester and the short point.
- 3 Breaks and shorts may generate some heat and they can also be found with infrared cameras scanned over the floor.

# 13 Control card

Perform all six (6) insulation and resistance test steps required during installation:

- 1 Before breaking the security seal and opening the product.

**Note:** *Once the seal is broken, you are then in charge of the cable integrity throughout the entire installation process. Be sure to follow instructions and observe all precautionary measures.*

- 2 After the installation of the heating cable.
- 3 Before embedding the heating cable.
- 4 After embedding the heating cable.
- 5 After the final installation of floor covering.
- 6 Before connecting the heating cable system.

Enter results in the measurement table found in the envelope.

Affix the measurement table to the electrical panel, once completed.

<b>Tableau de mesures</b> - Apposer au tableau électrique <b>Measurement table</b> - Place in electrical panel	Résistance Resistance ( $\Omega$ )	Isolation Insulation > 1M $\Omega$
<b>Résultats d'usine/Factory results</b>	Ex. : 11.52	OK
1. Avant de briser le sceau/ <i>Before breaking seal</i>		
2. Après la pose du câble/ <i>After cable installation</i>		
3. Avant l'enrobage du câble/ <i>Before embedding cable</i>		
4. Après l'enrobage du câble/ <i>After embedding cable</i>		
5. Après la pose finale du revêtement/ <i>After final surfacing</i>		
6. Avant raccordement du système/ <i>Before wiring the system</i>		