

TOP / DESSUS

R241606
STEEL / ACIER

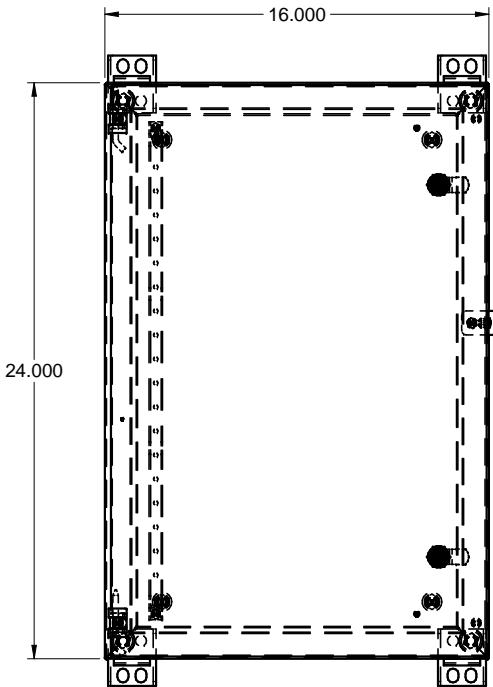

FRONT / FACE

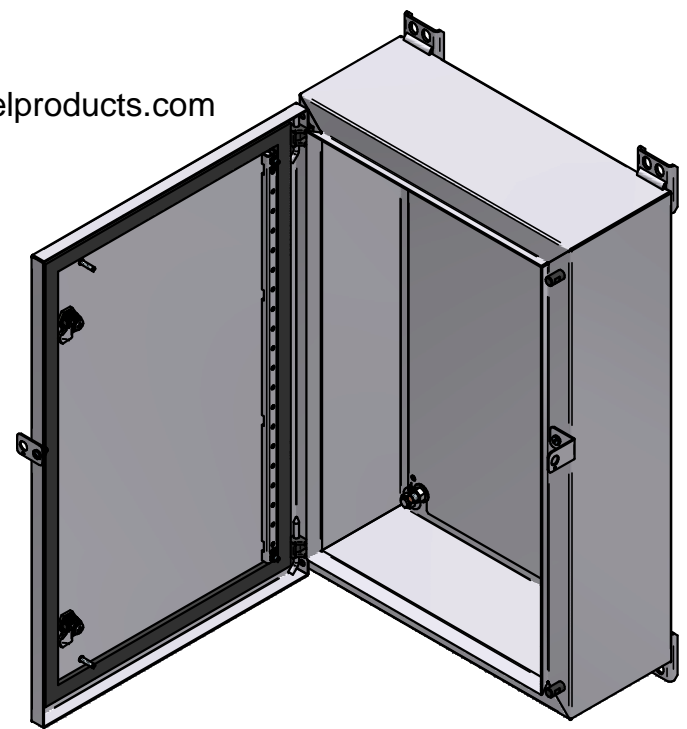
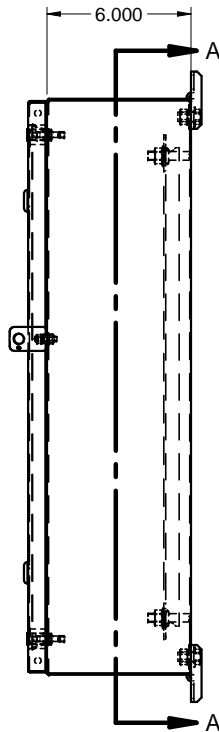

SIDE / CÔTÉ

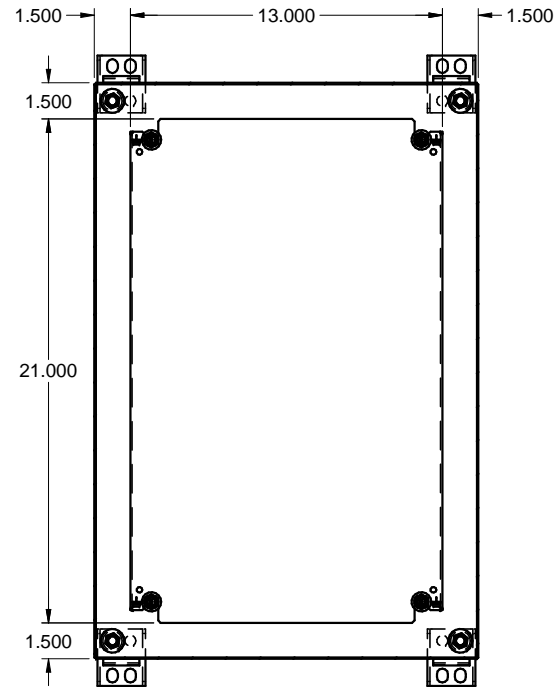

SECTION A-A

