

TOP / DESSUS

R202008
STEEL / ACIER

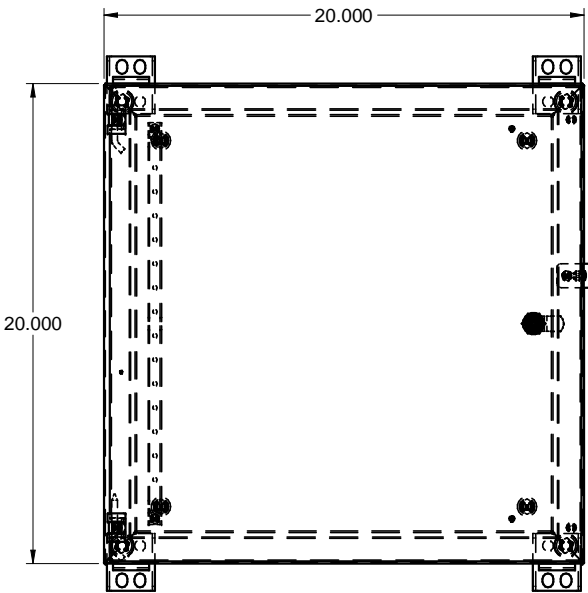

FRONT / FACE

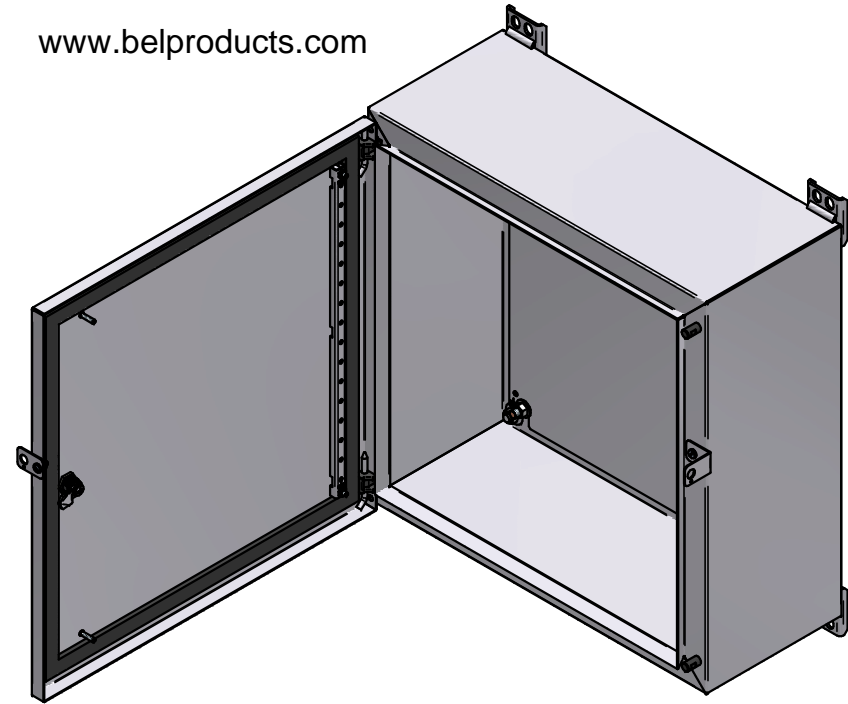
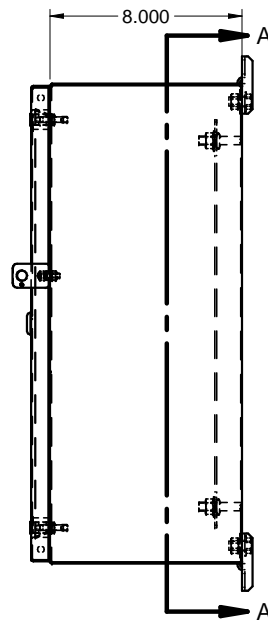

SIDE / CÔTÉ

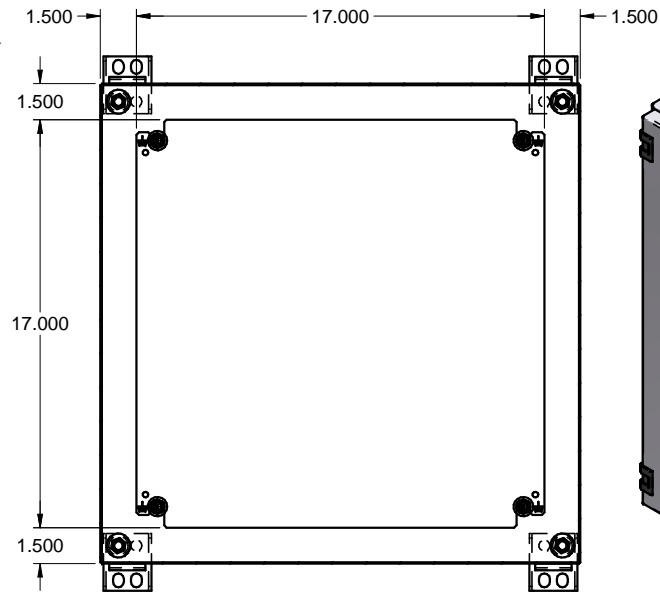

SECTION A-A

