

T5203
STEEL / ACIER

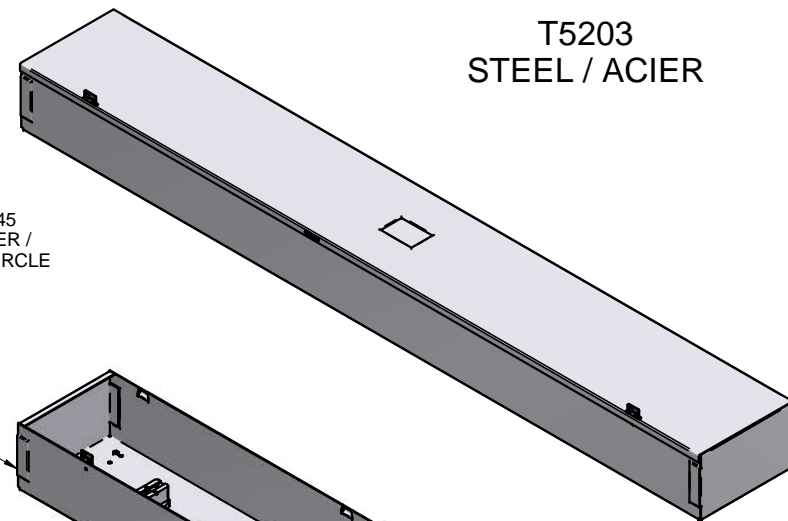

EMBOSS FOR SPOTWELD
EMBOSE POUR SOUDURE PAR POINT

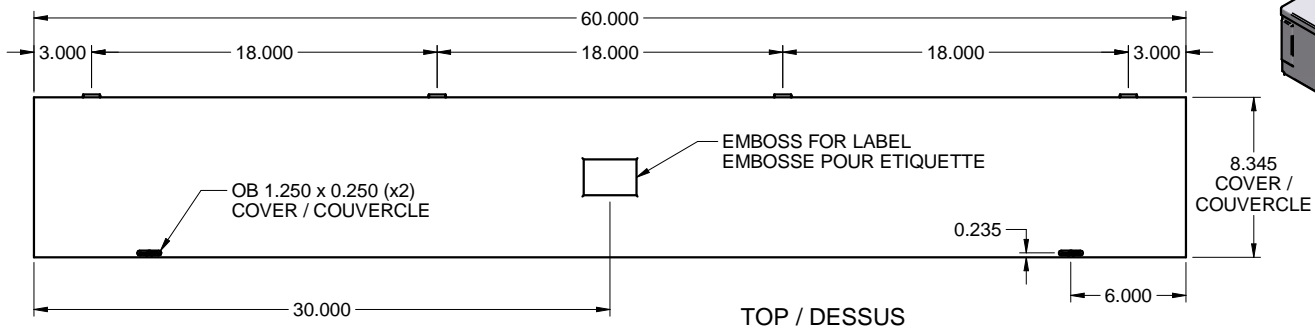
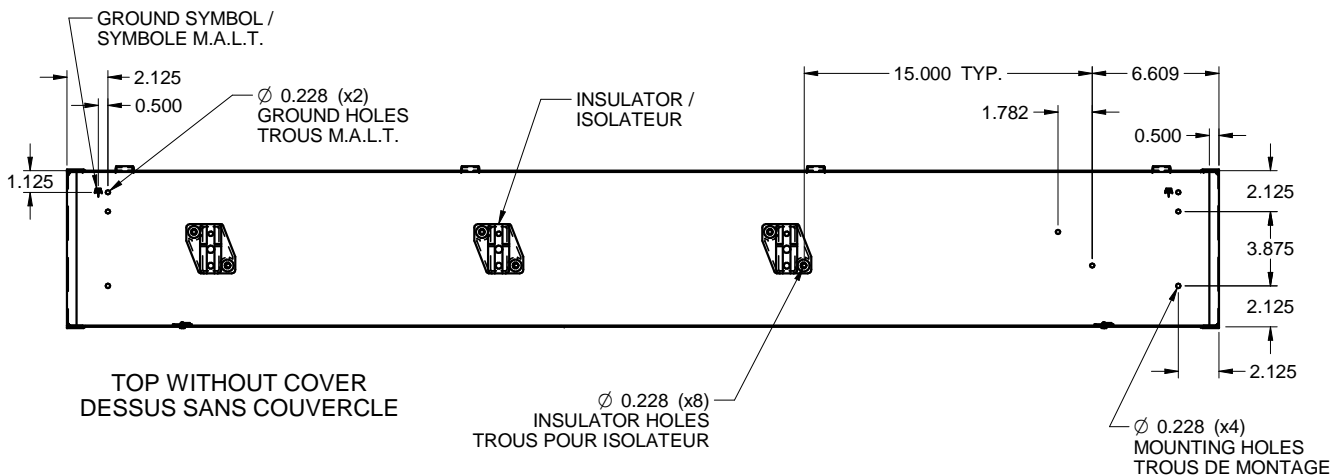
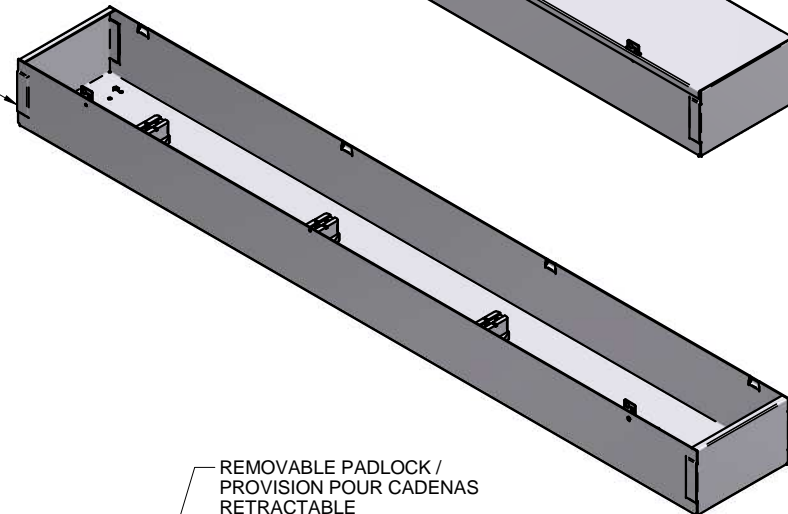

REMOVABLE PADLOCK /
PROVISION POUR CADENAS
RETRACTABLE

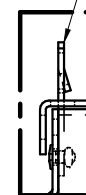

DETAIL B

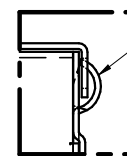

DETAIL A

FORMED HINGES /
PENTURES FORMÉES

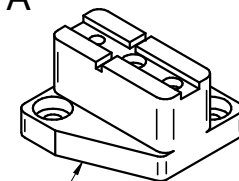
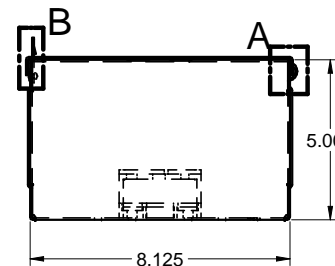
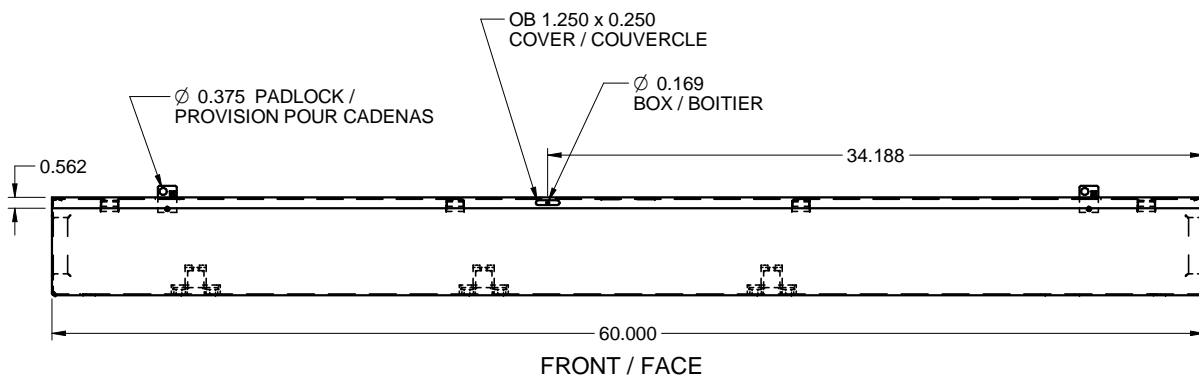

INSULATOR #BEL33
ISOLATEUR #BEL33