

T6403 / T6603
STEEL / ACIER

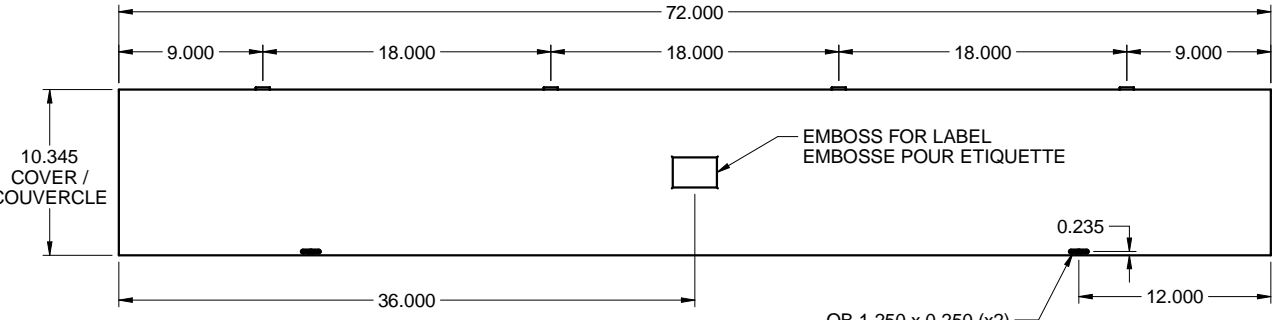

TOP / DESSUS

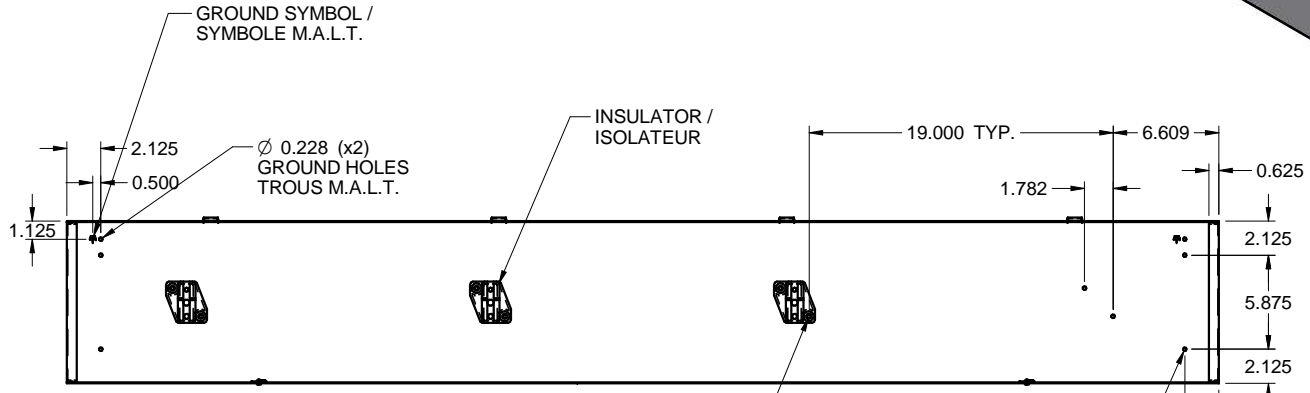
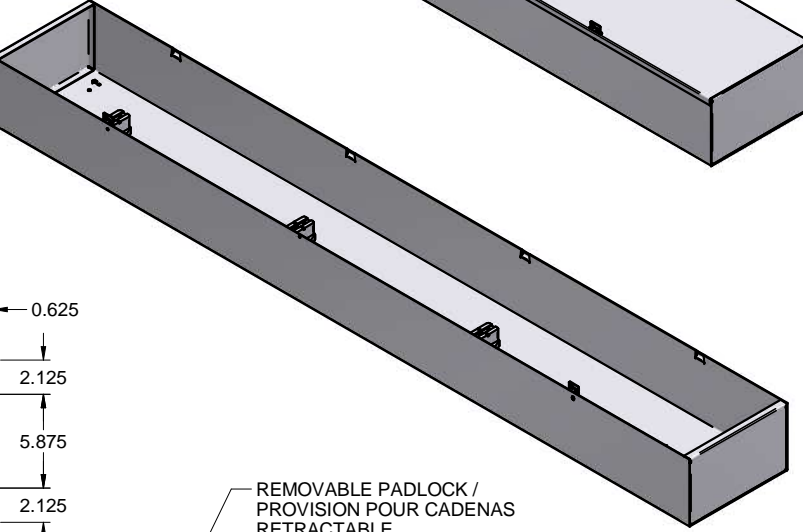
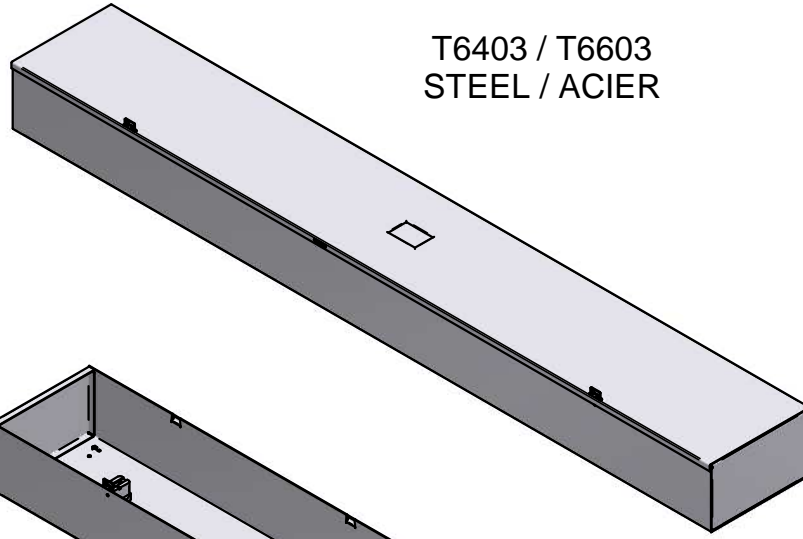

TOP WITHOUT COVER
DESSUS SANS COUVERCLE

INSULATOR /
ISOLATEUR

Ø 0.228 (x4)
MOUNTING HOLES
TROUS DE MONTAGE

REMOVABLE PADLOCK /
PROVISION POUR CADENAS
RETRACTABLE

FORMED HINGES /
PENTURES FORMÉES

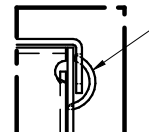
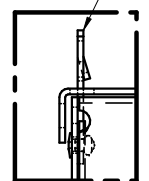

DETAIL B

DETAIL A

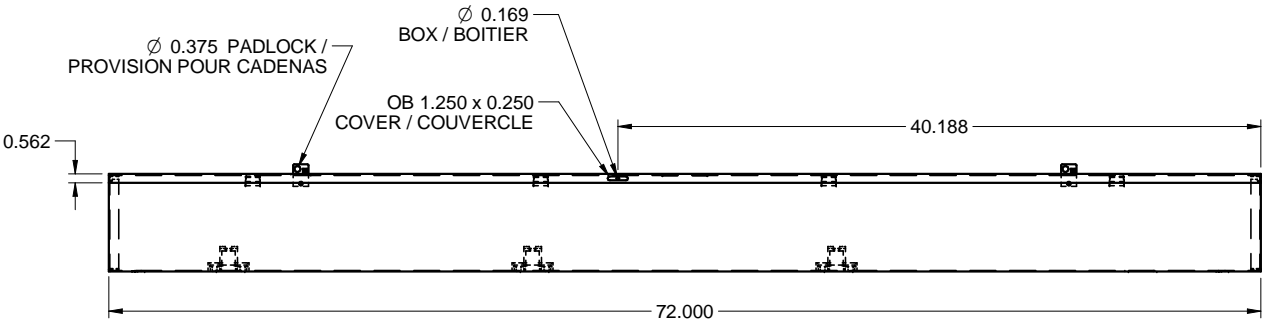

FRONT / FACE

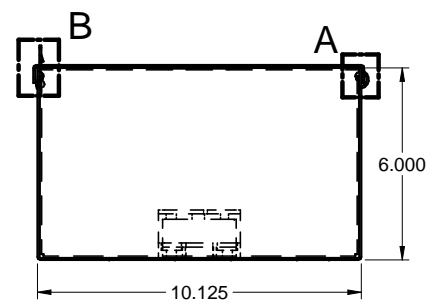

SIDE / CÔTÉ

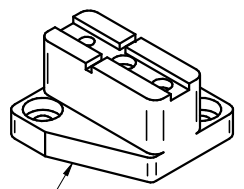

INSULATOR #BEL33
ISOLATEUR #BEL33