

DWPF101006
STEEL / ACIER

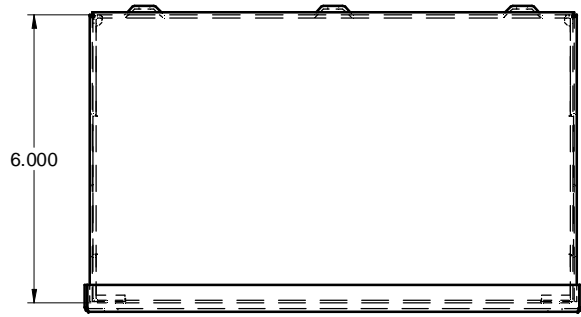

TOP / DESSUS

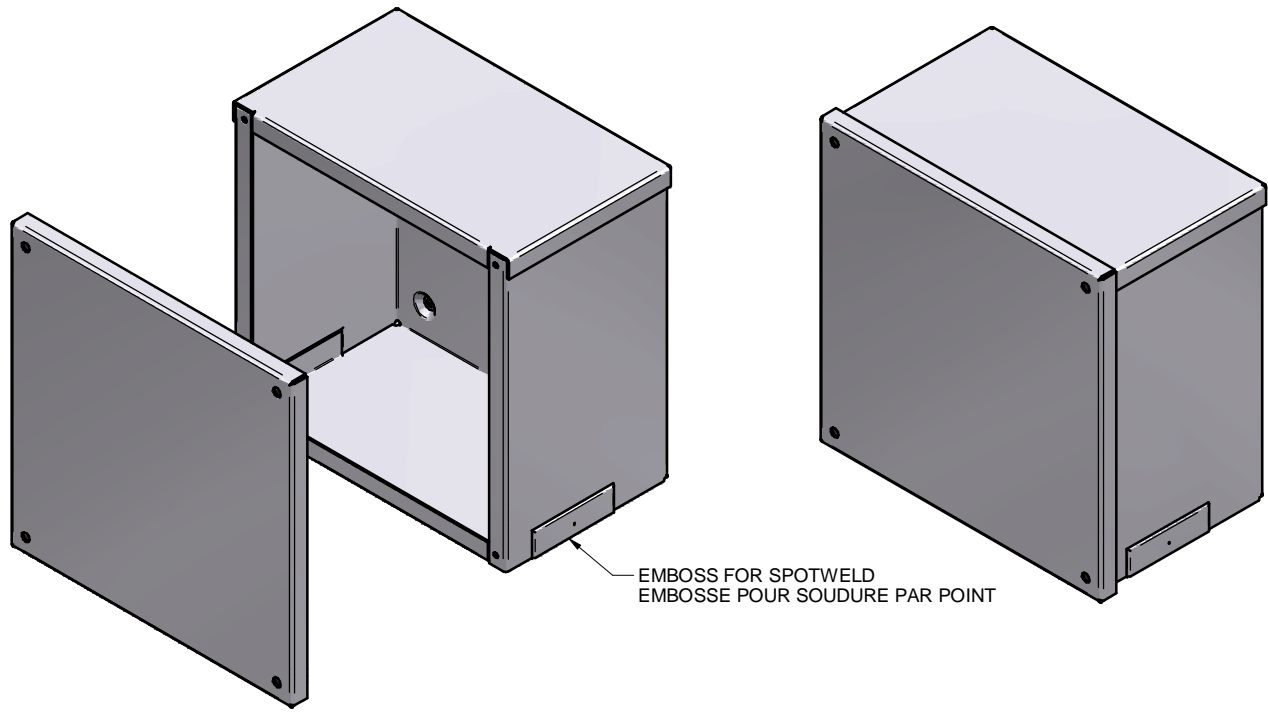

EMBOSS FOR SPOTWELD
EMBOSSÉ POUR SOUDURE PAR POINT

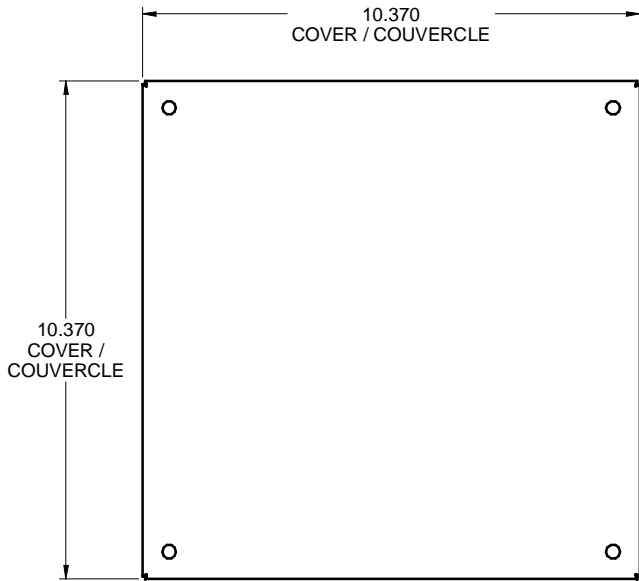

FRONT / FACE

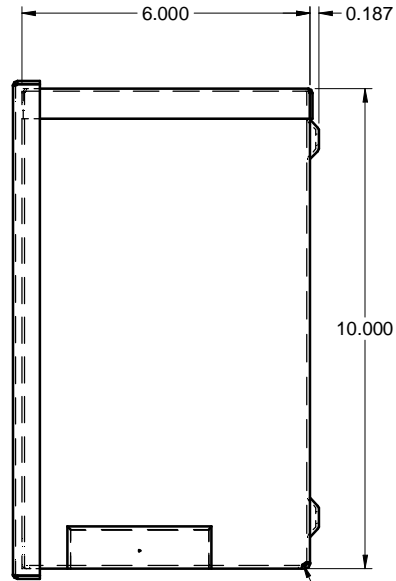

SIDE / CÔTÉ

DRAIN HOLE /
TROU DE DRAINAGE
(x2)

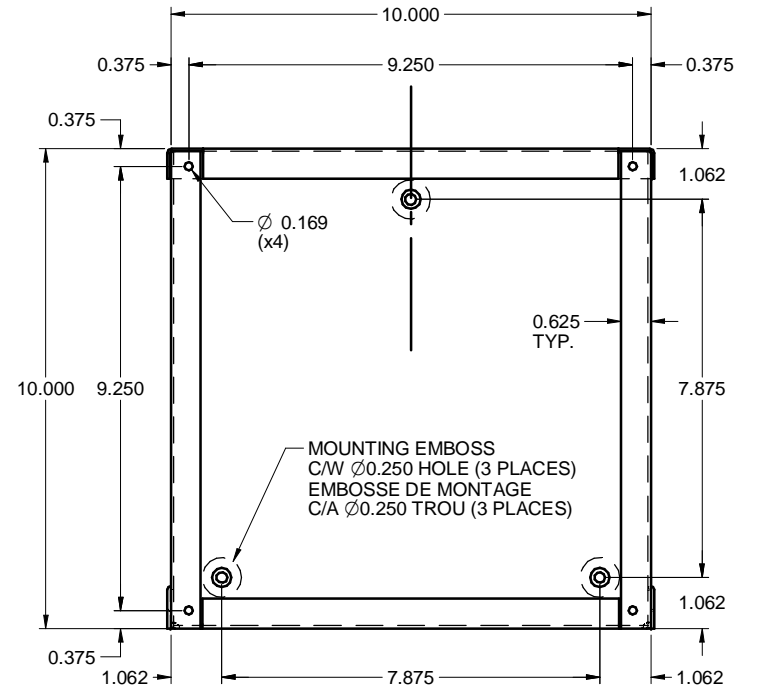

FRONT WITHOUT COVER
FACE SANS COUVERCLE

MOUNTING EMBOSS
C/W Ø0.250 HOLE (3 PLACES)
EMBOSSÉ DE MONTAGE
C/A Ø0.250 TROU (3 PLACES)