

T4400
STEEL / ACIER

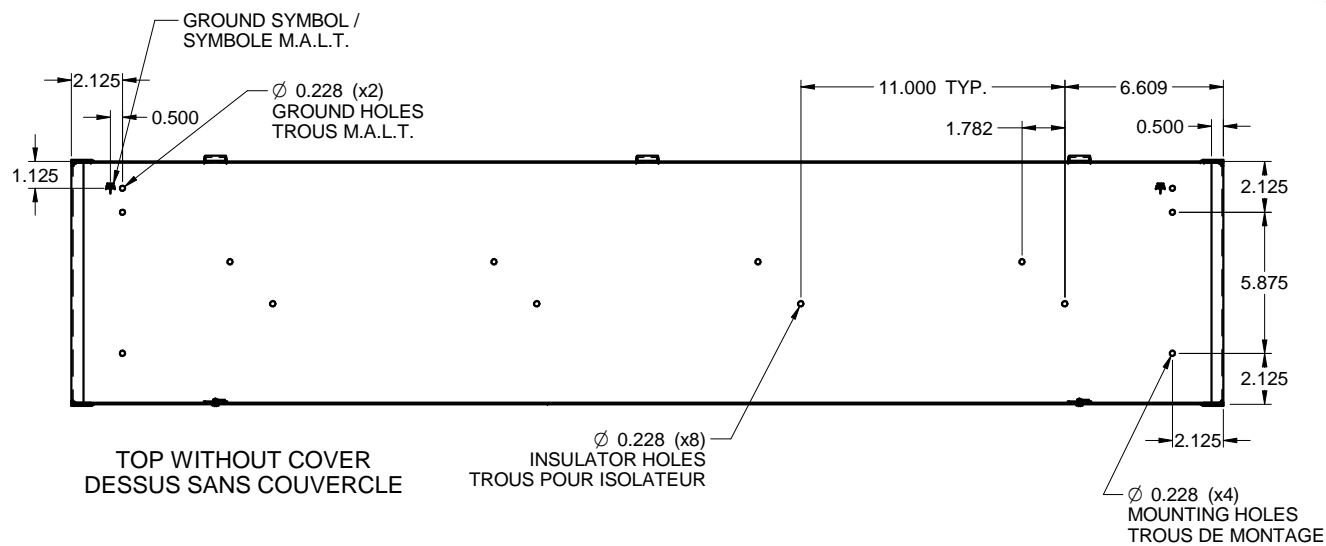

REMOVABLE PADLOCK /
PROVISION POUR CADENAS
RETRACTABLE

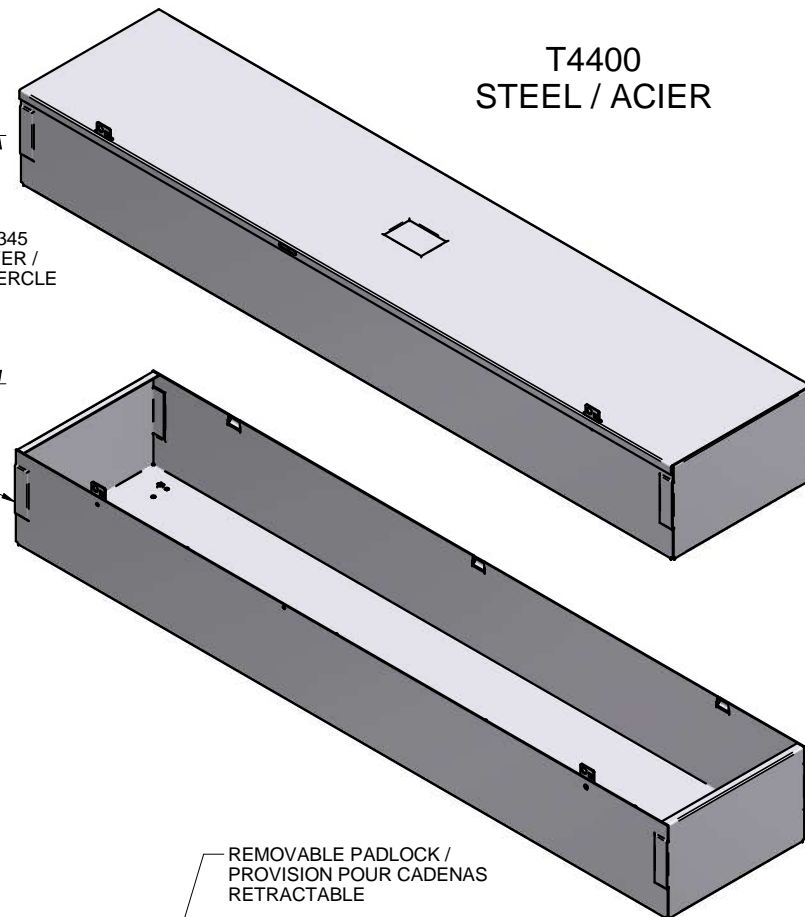
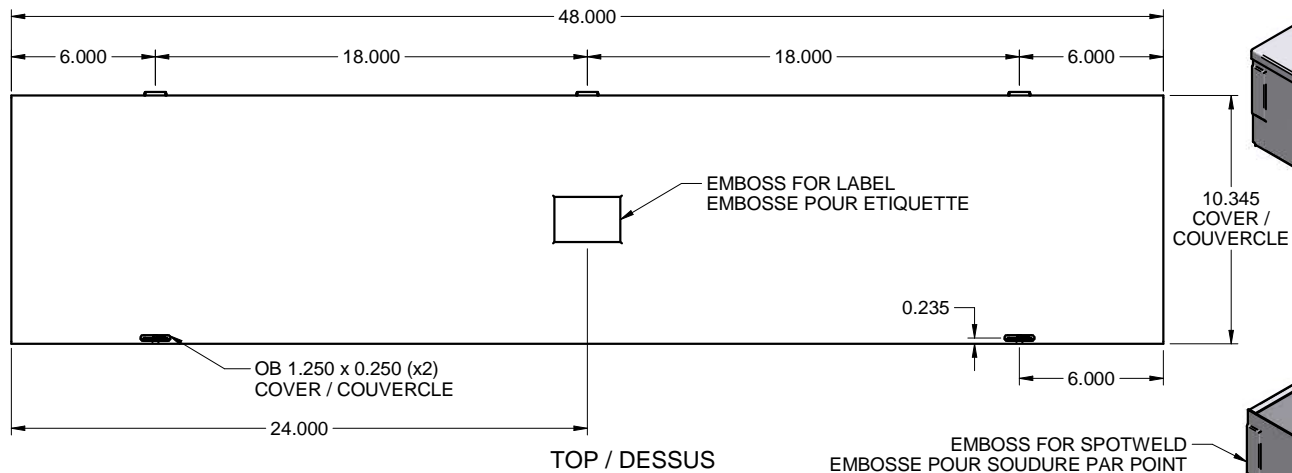
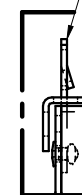

DETAIL B

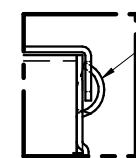

FORMED HINGES /
PENTURES FORMÉES

DETAIL A

