

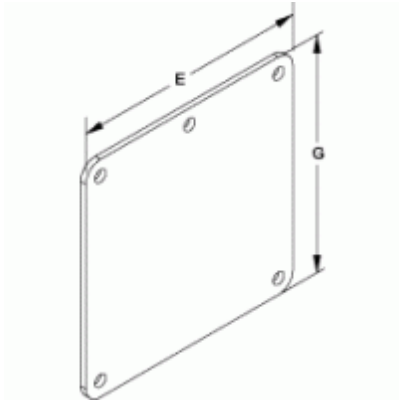

Quality Products. Service Excellence.

Cover Plate 1485 H Series



Construction

- Covers are formed from 10 gauge mild steel.
- Solid oil resistant gasket and hardware included with each cover plate.

Finish

- Finished in ANSI 61 gray.

Part No.	For use with	H	W
1485BH	2.5 x 2.5	3.87	3.87
1485CH	4 x 4	5.37	5.37
1485DH	6 x 6	7.62	7.62
1485EH	8 x 8	9.62	9.62
1485FH	12 x 6	13.62	7.62

One angled sealing plate included

Maintains ratings on CSA and UL approved wireway

Data subject to change without notice

© 2022. Hammond Manufacturing Ltd. All rights reserved.