

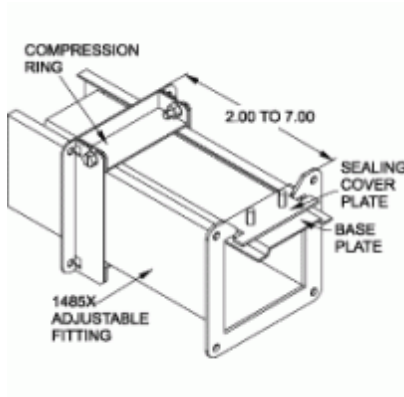

Quality Products. Service Excellence.

Adjustable Fitting *1485 X Series*



- Allows on site length adjustment of 2" to 7"

Part No.	Size
1485BX	2.5 x 2.5
1485CX	4 x 4
1485DX	6 x 6
1485EX	8 x 8
1485FX	12 x 6

One special sealing plate included
Does not meet CSA or UL requirements



Data subject to change without notice

© 2022. Hammond Manufacturing Ltd. All rights reserved.