

# FS and FD Cast Hub Device Boxes

UNILETS™ for use with Threaded Rigid Conduit and IMC. All device boxes have ridge top construction.

**CEC:**  
Listed for Ordinary Locations

## Applications

- Accommodate wiring devices such as switches and receptacles.
- Provide excellent service in areas where boxes are subject to rough usage.
- Serve as pull boxes for conductors.
- Permit access to conductors for maintenance.
- Provide openings for making splices.
- Allow connections for branch conduit runs.
- Blank bodies for special conduit entrance arrangements.

## Features

- Weatherproof, raintight and dust-tight when used with cast gasketed covers.
- FS and FD boxes take standard flush wiring devices.
- FD boxes take devices exceeding 1-5/8" in depth under fastening ears.
- Malleable iron for high tensile strength and ductility — provides greater resistance to impact and shock.
- Both malleable iron and aluminum boxes have ridge top construction for positive cover/gasket/box fit.
- Accurately tapped, tapered threads for tight, rigid joints, ground continuity.
- Complete selection of covers, receptacles, plugs, gaskets and accessories.
- Covers have captive stainless steel screws to speed installation, prevent "freezing" of screws.
- Ground screw at top of box for easy access.
- Cast Hub Boxes
  - Available in single, two, three and four gang and tandem.
  - Smooth, rounded integral bushing in each hub protects conductor insulation.
- FD Blank Bodies for Brazed Hubs or Drill and Tapped Entries
  - Available in single, two, three and four gang boxes.
  - Drill and tapped entries.
  - Brazed threaded hubs for threaded conduit from 1/2" thru 1-1/2" and brazed union hubs from 1/2" thru 1-1/4.
  - Smooth, rounded integral bushing in each hub protects conductor insulation.
  - Ground screw at top of box for easy access.

## Standard Materials

- Cast hub device boxes and boxes for drilling and tapping: malleable iron or copperfree (4/10 of 1% max.) aluminum
- Brazed hubs: malleable iron
- Covers: malleable iron, steel, or copperfree (4/10 of 1% max.) aluminum

## Standard Finishes

- Malleable iron boxes and covers: zinc electroplate
- Aluminum boxes and covers: natural
- Steel covers: zinc electroplate
- Screws: stainless steel

## Options

- Enclosures drilled for 347 Volt devices. Add suffix **-347**.

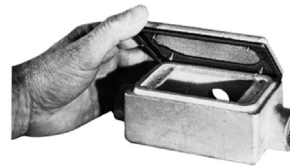
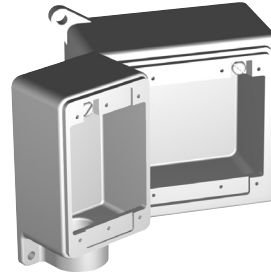

Gasket is designed so that it "wraps around" ridge top of Appleton™ aluminum or malleable iron device box. Result is a positive seal against moisture.

## CEC Certifications and Compliances

- CSA Standard: C22.2 No. 18.1
- CSA Certified: 001472

## Reference Data

- When ordering drilled and tapped openings or brazed hubs for blank bodies, refer to *FS and FD Cast Device Boxes Drilling and Tapping Information* pages.

# FS and FD Cast Hub Device Boxes

UNILETS™ for use with Threaded Rigid Conduit and IMC. All device boxes have ridge top construction.

CEC:  
Listed for Ordinary Locations



	Size	Malleable Iron			Aluminum		
		Weight kg (lb)	Catalog Number		Weight kg (lb)	Catalog Number	
	1/2		0.88 (1.94)	<b>FS-1</b>		0.29 (0.64)	<b>FS-1A</b>
	3/4	Shallow	1.02 (2.25)	<b>FS-2</b>	Shallow	0.34 (0.75)	<b>FS-2A</b>
	1		0.88 (1.94)	<b>FS-3</b>		0.29 (0.64)	<b>FS-3A</b>
	1/2		1.22 (2.70)	<b>FD-1</b>		0.41 (0.90)	<b>FD-1A</b>
	3/4	Deep	1.18 (2.60)	<b>FD-2</b>	Deep	0.42 (0.92)	<b>FD-2A</b>
	1		1.27 (2.80)	<b>FD-3</b>		0.43 (0.94)	<b>FD-3A</b>
	1/2	Shallow	0.77 (1.70)	<b>FSA-1</b>	Shallow	0.26 (0.57)	<b>FSA-1A</b>
	3/4		0.73 (1.60)	<b>FSA-2</b>		0.26 (0.58)	<b>FSA-2A</b>
	1/2	Deep	0.95 (2.10)	<b>FDA-1</b>	Deep	0.32 (0.70)	<b>FDA-1A</b>
	3/4		0.91 (2.00)	<b>FDA-2</b>		0.30 (0.67)	<b>FDA-2A</b>
	1/2		0.95 (2.10)	<b>FSC-1</b>		0.32 (0.70)	<b>FSC-1A</b>
	3/4	Shallow	1.09 (2.40)	<b>FSC-2</b>	Shallow	0.36 (0.80)	<b>FSC-2A</b>
	1		0.93 (2.06)	<b>FSC-3</b>		0.32 (0.70)	<b>FSC-3A</b>
	1/2		1.27 (2.80)	<b>FDC-1</b>		0.43 (0.94)	<b>FDC-1A</b>
	3/4	Deep	1.27 (2.80)	<b>FDC-2</b>	Deep	0.43 (0.94)	<b>FDC-2A</b>
	1		1.36 (3.00)	<b>FDC-3</b>		0.45 (1.00)	<b>FDC-3A</b>
	1/2	Shallow	0.77 (1.70)	<b>FSCC-1</b>	Shallow	0.26 (0.57)	<b>FSCC-1A</b>
	3/4		0.99 (2.20)	<b>FSCC-21</b> ①		0.34 (0.74)	<b>FSCC-21A</b> ①
	1/2		1.13 (2.50)	<b>FSCT-1</b>		0.38 (0.84)	<b>FSCT-1A</b>
	3/4	Shallow	1.13 (2.50)	<b>FSCT-2</b>	Shallow	0.38 (0.84)	<b>FSCT-2A</b>
	1		1.02 (2.25)	<b>FSCT-3</b>		0.34 (0.75)	<b>FSCT-3A</b>
	1/2		1.36 (3.00)	<b>FDCT-1</b>		0.45 (1.00)	<b>FDCT-1A</b>
	3/4	Deep	1.27 (2.80)	<b>FDCT-2</b>	Deep	0.43 (0.94)	<b>FDCT-2A</b>
	1		1.41 (3.10)	<b>FDCT-3</b>		0.47 (1.03)	<b>FDCT-3A</b>
	1/2	Deep	0.99 (2.20)	<b>FDD-1</b>	Deep	0.34 (0.74)	<b>FDD-1A</b>
	3/4		1.04 (2.30)	<b>FDD-2</b>		0.35 (0.77)	<b>FDD-2A</b>
	3/4	Shallow	1.06 (2.34)	<b>FSL-2</b>	Shallow	0.35 (0.78)	<b>FSL-2A</b>

① Use FD Unilets™ for wiring devices exceeding 1-5/8" in depth under fastening ears.

# FS and FD Cast Hub Device Boxes

UNILETS™ for use with Threaded Rigid Conduit and IMC. All device boxes have ridge top construction.

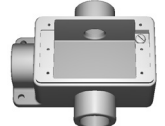
CEC:  
Listed for Ordinary Locations

	Size		Malleable Iron Weight kg (lb)	Catalog Number		Aluminum Weight kg (lb)	Catalog Number
	1/2	Shallow	0.82 (1.80)	<b>FSS-1</b>	Shallow	0.27 (0.60)	<b>FSS-1A</b>
	3/4		0.82 (1.80)	<b>FSS-2</b>		0.27 (0.60)	<b>FSS-2A</b>
	1/2	Shallow	1.12 (2.46)	<b>FST-1</b>	Shallow	0.37 (0.82)	<b>FST-1A</b>
	3/4		1.06 (2.33)	<b>FST-2</b>		0.35 (0.78)	<b>FST-2A</b>
	1	Deep	1.45 (3.20)	<b>FDT-3</b>	Deep	0.49 (1.07)	<b>FDT-3A</b>
	1/2	Shallow	1.25 (2.75)	<b>FSX-1</b>	Shallow	0.41 (0.91)	<b>FSX-1A</b>
	3/4		1.06 (2.34)	<b>FSX-2</b>		0.35 (0.78)	<b>FSX-2A</b>
	1/2	Deep	1.41 (3.10)	<b>FDX-1</b>	Deep	0.47 (1.03)	<b>FDX-1A</b>
	3/4		1.36 (3.00)	<b>FDX-2</b>		0.48 (1.06)	<b>FDX-2A</b>
	1		1.59 (3.50)	<b>FDX-3</b>		0.53 (1.17)	<b>FDX-3A</b>

## Dimensions in Millimeters (Inches)

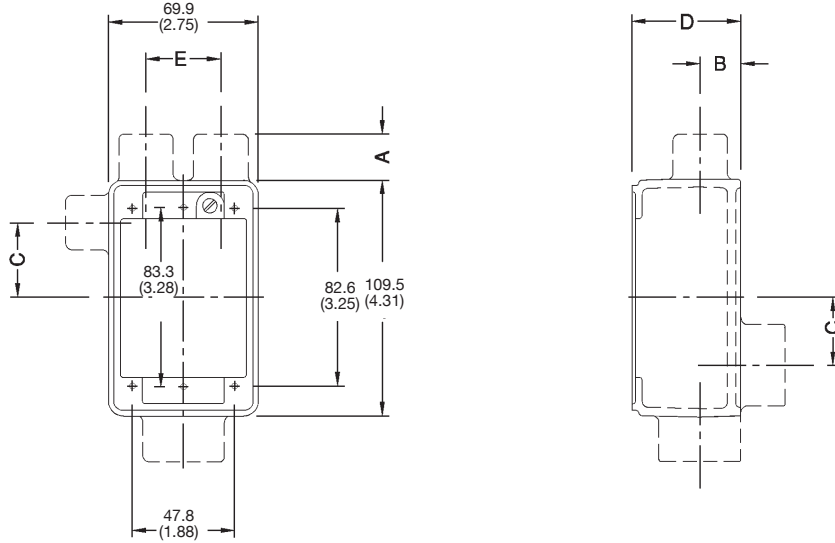

FS and FD Single Gang Devices

Hub Size	A	B	C	D		E
				FS	FD	
1/2	0.3 (0.75)	0.3 (0.63)	0.6 (1.38)	0.9 (2.00)	1.3 (2.75)	0.6 (1.38)
3/4	0.3 (0.75)	0.3 (0.75)	0.6 (1.38)	0.9 (2.00)	1.3 (2.75)	0.6 (1.38)
1	0.4 (0.88)	0.4 (0.88)	0.8 (1.25)	0.9 (2.00)	1.3 (2.75)	0.6 (1.38)

COMMERCIAL AND INDUSTRIAL FITTINGS: CAST DEVICE BOXES

APPLETON™

# FS and FD Cast Hub Device Boxes

UNILETS™ for use with Threaded Rigid Conduit and IMC.

**CEC:**  
Listed for Ordinary Locations

	Description	Weight Per 100 kg (lb)	Catalog Number
<b>Single Gang Covers — Furnished with stainless steel screws less gasket</b>			
	Blank Cover, Steel — Zinc Electroplate	5.44 (12.00)	<b>FS-4</b> ①
	Round Receptacle Cover, Steel — Zinc Electroplate Hole dia. 1-7/16"	5.44 (12.00)	<b>FS-5</b> ①
	Duplex Receptacle Cover, Steel — Zinc Electroplate	4.54 (10.00)	<b>FS-6</b> ①
	Round Receptacle Cover, Steel — Zinc Electroplate Hole dia. 1-5/8"	5.44 (12.00)	<b>FS-8</b> ①
	Tumbler Switch Cover, Steel — Zinc Electroplate	5.44 (12.00)	<b>FS-9</b> ①
	Tumbler Switch Cover, Steel — Zinc Electroplate  For pilot lamp	9.98 (22.00)	<b>FSK-1TS-G</b> ②
	Red Jewel		<b>FSK-1J</b> ②
	Amber Jewel	11.34 (25.00)	<b>FSK-1JA</b> ②
	Green Jewel		<b>FSK-1JG</b> ②
	Opal Jewel		<b>FSK-1JO</b> ②

① Available in Aluminum: Add suffix **-A** to Catalog Number.  
② Also for use with multiple gang Unilets with individual cover openings.











# FS and FD Cast Hub Device Boxes

UNILETS™ for use with Threaded Rigid Conduit and IMC.

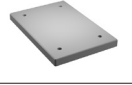
NEC/CEC:  
Listed for Ordinary Locations

COMMERCIAL AND INDUSTRIAL FITTINGS: CAST DEVICE BOXES

APPLETON™

Description	Catalog Number	
	Malleable Iron Ridge Top	Aluminum Ridge Top
<b>Cast Covers NEMA 3 – Weatherproof – Furnished with gasket and stainless steel screws</b>		
 Receptacle cover with spring cover. Hole Diameter – 1-7/16"	<b>FSK-1VR</b>	—
 Rocker type for square handle tumbler or toggle switches	<b>FSK-1V</b>	<b>FSK-1V-A</b>
 For duplex flush receptacle with spring cover	<b>FSK-1VDR</b>	<b>FSK-1VDR-A</b>
 For external operation of tumbler switches with square handles	<b>FSK-1VTS</b>	<b>FSK-1VTS-A</b>
 Operating type for square handle tumbler or toggle switches	<b>FSK-1VS</b>	<b>FSK-1VS-A</b>
 Blank Cover and Gasket, Malleable Iron, Zinc Electroplate	—	<b>FS-100G</b>
<b>Gasket – Replacement</b>		
 Neoprene – for use with weatherproof covers	<b>FS-GKR-1N</b>	<b>FS-GKR-1N</b>
<b>Cast Covers Dry Locations – Furnished with stainless steel screws less gasket</b>		
 For standard 2 or 3 wire duplex receptacles	<b>FSK-1DR-C</b>	—
 For round flush receptacles. Hole dia. 1-7/16"	<b>FSK-1R-Z</b>	—
 For square handle toggle switches	<b>FSK-1TS-C</b>	—
 For square handle toggle switches (with protecting guard)	<b>FSK-1TSG-C</b>	<b>FSK-1TSG-CA</b>

# FS and FD Cast Hub Device Boxes

## Weatherproof, Raintight and Dust-tight

Covers for Ridge Top Boxes.

NEC/CEC:  
Listed for Ordinary Locations

Receptacle	Plug	Pole/Wire	Catalog Number		
			Receptacles Malleable Iron Ridge Top	Receptacles Aluminum Ridge Top	Plug

Receptacle cover has threaded aluminum cap. Plug has neoprene boot and aluminum fastening ring. Furnished with receptacle, neoprene gasket, stainless steel screws.

### Non-Locking, "U" Shaped Grounding Type – Receptacle takes "U" shaped or round grounding contact plugs



#### 15 Amp, 125V

NEMA 5-15R		NEMA 5-15P		2P, 3W	FSK5-15	FSK5-15-A	FSWP5-15
------------	--	------------	--	--------	---------	-----------	----------

#### 20 Amp, 125V

NEMA 5-20R		NEMA 5-20P		2P, 3W	FSK5-20 ①	FSK5-20-A ①	FSWP5-20
------------	--	------------	--	--------	-----------	-------------	----------



#### 15 Amp, 250V

NEMA 6-15R		NEMA 6-15P		2P, 3W	FSK6-15	FSK6-15-A	FSWP6-15
------------	--	------------	--	--------	---------	-----------	----------

#### 20 Amp, 250V

NEMA 6-20R		NEMA 6-20P		2P, 3W	FSK6-20 ②	FSK6-20-A	FSWP6-20
------------	--	------------	--	--------	-----------	-----------	----------

### Locking Grounding Type



#### 15 Amp, 125V

NEMA L5-15R		NEMA L5-15P		2P, 3W	FSKL5-15		FSWPL5-15
-------------	--	-------------	--	--------	----------	--	-----------

#### 15 Amp, 250V

NEMA L6-15R		NEMA L6-15P		2P, 3W	FSKL6-15		FSWPL6-15
-------------	--	-------------	--	--------	----------	--	-----------



#### 15 Amp, 277V

NEMA L7-15R		NEMA L7-15P		2P, 3W	FSKL7-15		FSWPL7-15
-------------	--	-------------	--	--------	----------	--	-----------

① Also takes FSWP5-15 Plugs.

② Also takes FSWP6-15 Plugs.

# FS and FD Cast Hub Device Boxes

UNILETS™ for use with Threaded Rigid Conduit and IMC. All device boxes have ridge top construction.

CEC:  
Listed for Ordinary Locations

	Size		Gray Iron Weight kg (lb)	Catalog Number		Aluminum Weight kg (lb)	Catalog Number
	1/2	Shallow	1.22 (2.70)	<b>FS-12</b>	Shallow	0.41 (0.90)	<b>FS-12A</b>
	3/4		1.18 (2.60)	<b>FS-22</b>		0.39 (0.87)	<b>FS-22A</b>
	1/2	Deep	1.22 (2.70)	<b>FD-12</b>	Shallow	0.41 (0.90)	<b>FD-12A</b>
	3/4		1.22 (2.70)	<b>FD-22</b>		0.41 (0.90)	<b>FD-22A</b>
	1		1.27 (2.80)	<b>FD-32</b>		0.42 (0.93)	<b>FD-32A</b>
	1/2	Shallow	1.36 (3.00)	<b>FSC-12</b>	Shallow	0.45 (1.00)	<b>FSC-12A</b>
	3/4		1.36 (3.00)	<b>FSC-22</b>		0.45 (1.00)	<b>FSC-22A</b>
	1/2	Deep	1.32 (2.90)	<b>FDC-12</b>	Deep	0.44 (0.97)	<b>FDC-12A</b>
	3/4		1.36 (3.00)	<b>FDC-22</b>		0.48 (1.06)	<b>FDC-22A</b>
	1		1.41 (3.10)	<b>FDC-32</b>		0.47 (1.03)	<b>FDC-32A</b>
	1/2 - 3/4	Shallow	1.22 (2.70)	<b>FSD-212</b> ①	Shallow	0.41 (0.90)	<b>FSD-212A</b> ①

## Dimensions in Millimeters (Inches)

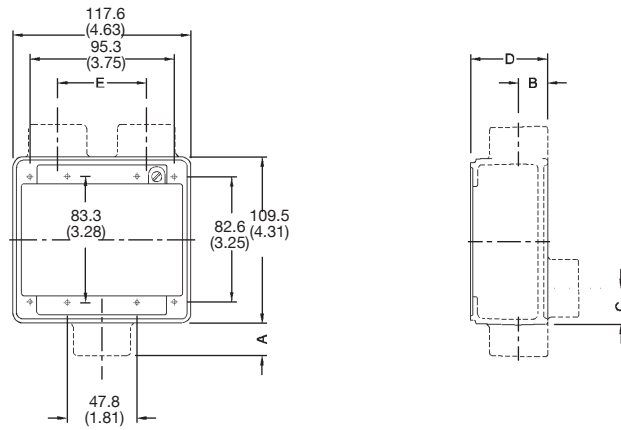

FS and FD Two-Gang Devices









Hub Size	Dimensions in Millimeters (Inches)					
	A	B	C	D		E
1/2	19.1 (0.75)	16.0 (0.63)	35.1 (1.38)	FS: 50.8 (2.00)	FD: 69.9 (2.75)	58.7 (2.31)
3/4	19.1 (0.75)	19.1 (0.75)	35.1 (1.38)	FS: 50.8 (2.00)	FD: 69.9 (2.75)	58.7 (2.31)
1	22.4 (0.88)	22.4 (0.88)	31.8 (1.25)	FS: 50.8 (2.00)	FD: 69.9 (2.75)	58.7 (2.31)

① Hubs at top of illustration are 1/2".

# FS and FD Cast Hub Device Boxes

UNILETS™ for use with Threaded Rigid Conduit and IMC.

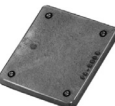
**CEC:**  
Listed for Ordinary Locations



	Description	Weight Per 100 kg (lb)	Catalog Number
<b>Two Gang Covers</b>			
	Blank Cover, Steel – Zinc Electroplate	9.07 (20.00)	<b>FS-42</b> ①
	Round Receptacle Cover, Steel – Zinc Electroplate Hole dia. 1-7/16"	8.16 (18.00)	<b>FS-52</b> ①
	Duplex Receptacle Cover, Steel-Zinc Electroplate	6.80 (15.00)	<b>FS-62</b> ①
	Tumbler Switch Cover, Steel –Zinc Electroplate	9.07 (20.00)	<b>FS-92</b> ①
	Combination Duplex Receptacle and Tumbler Switch Cover, Steel - Zinc Electroplate	6.80 (15.00)	<b>FS-69</b> ①
	Combination Duplex Receptacle and Single Receptacle, Steel - Zinc Electroplate	6.80 (15.00)	<b>FS-65</b> ①
<b>Weatherproof Covers</b>			
	Blank Cover, Gray Iron	25.40 (56.00)	<b>FS-200G</b> ①
<b>Gasket – Replacement</b>			
	Neoprene - for use with 2-gang cast covers above	—	<b>FS-GKR-2N</b>

① Available in Aluminum: Add suffix **-A** to catalog number.

# FS and FD Cast Hub Device Boxes

UNILETS™ for use with Threaded Rigid Conduit and IMC. All device boxes have ridge top construction.

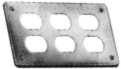
CEC:  
Listed for Ordinary Locations

	Description	Weight Per 100 kg (lb)	Catalog Number
<b>Three Gang Covers</b>			
	Duplex Receptacle Cover, Steel – Zinc Electroplate	10.43 (23.00)	<b>FS-63</b> ①
	Tumbler Switch, Steel –Zinc Electroplate	11.34 (25.00)	<b>FS-93</b> ①
<b>Weatherproof Covers</b>			
	Blank Cover, Gray Iron	54.43 (120.00)	<b>FS-300G</b> ①

COMMERCIAL AND INDUSTRIAL FITTINGS: CAST DEVICE BOXES

APPLETON™

① Available in Aluminum: Add suffix -A to catalog number.

# FDO Single and Multiple Gang Cast Device Boxes

UNILETS™ for use with Threaded Rigid Conduit and IMC. All device boxes have ridge top construction.

**CEC:**  
Listed for Ordinary Locations

## Features

- Thick wall on all four sides.
- Drill and tap anywhere on sidewalls.
- Ground screw at top of box for easy access.
- Two exterior mounting lugs.
- Fits standard sheet metal device covers with four mounting holes.
- Weatherproof when used with gasketed cast weatherproof device covers.

## Standard Materials



- Malleable iron or copperfree (4/10 of 1% max.) aluminum

## Standard Finishes

- Malleable iron: zinc electroplate
- Aluminum: natural

## Reference Data

- When ordering drilled and tapped openings or brazed hubs for blank bodies, refer to *FDO Cast Device Boxes Drilling and Tapping Information page*.

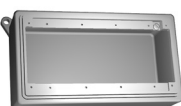
	Description	Catalog Number	
		Gray Iron	Aluminum
<b>FD0 Unilets with Lugs: FD depth 2-19/32" — Maximum hub size 1-1/2" threaded, and 1-1/4" no-thread or union.</b>			
	Single-Gang	FD0-1	FD0-1A
	Two-Gang	FD0-2	FD0-2A
	Three-Gang	FD0-3	FD0-3A
	Four-Gang	FD0-4	FD0-4A

# FDO Single and Multiple Gang Cast Device Boxes

UNILETS™ for use with Threaded Rigid Conduit and IMC. All device boxes have ridge top construction.

CEC:  
Listed for Ordinary Locations

## Dimensions in Millimeters (Inches)

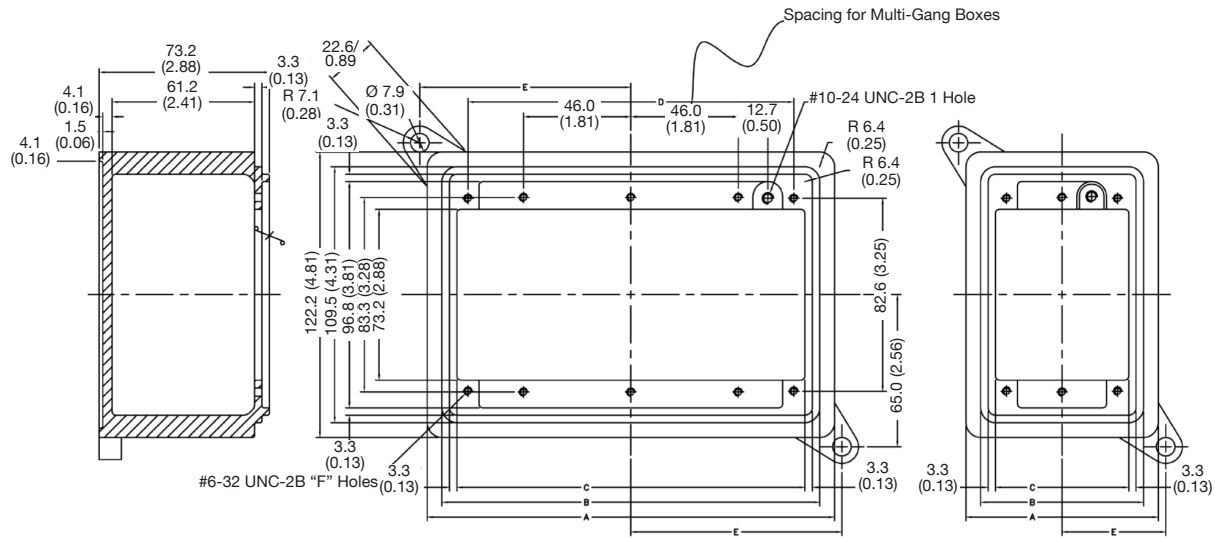

FDO Unilets

No. of Gangs	A	B	C	D	E	F
1	82.60 (3.25)	69.90 (2.75)	58.67 (2.31)	47.80 (1.88)	44.50 (1.75)	152.40 (6.00)
2	130.30 (5.13)	117.60 (4.63)	106.40 (4.19)	95.30 (3.75)	68.30 (2.69)	203.20 (8.00)
3	177.80 (7.00)	165.10 (6.50)	154.00 (6.06)	143.00 (5.63)	92.20 (3.63)	254.00 (10.00)
4	225.60 (8.88)	212.90 (8.38)	201.70 (7.94)	190.50 (7.50)	115.80 (4.56)	304.80 (12.00)

# FDO Single and Multiple Gang Cast Device Boxes

## Malleable Iron, Aluminum

UNILETS™ for use with Threaded Rigid Conduit and IMC. All device boxes have ridge top construction.

**CEC:**

*Listed for Ordinary Locations*

### Hub Information

Listed below are the various types of brazed hubs which may be used with the FDO boxes. Threaded, no-thread and union hubs may be brazed at any desired location.

It is possible to place more than five hubs on the top and bottom of three and four-gang Unilets.

Look at the chart below for the maximum hub diameter and the minimum hub spacing distance. This chart, together with the Unilet dimensions will enable you to figure the maximum number of hubs which may be used.

The hubs will be symmetrically placed about the axis of the Unilets unless exact dimensions are specified on the order.

	Size	Threaded for Rigid Conduit	No Thread for Rigid Conduit	No Thread for Electrical Metallic Tubing	Union
Maximum Hub Size	FS	1	3/4	3/4	3/4
	FD	1-1/2	1-1/4	1-1/4	1-1/4
Maximum Hub Diameter	1/2	1-1/8	1-1/2	1-1/8	1-1/2
	3/4	1-3/8	1-25/32	1-3/8	1-25/32
	1	1-9/16	2-1/32	1-9/16	2-1/32
	1-1/4	1-15/16	2-25/32	1-15/16	2-25/32
	1-1/2	2-3/16	—	—	—
Maximum Distance Between Conduit Centers	1/2	1-1/4	1-9/16	1-1/4	1-9/16
	3/4	1-1/2	1-27/32	1-1/2	1-27/32
	1	1-3/4	2-3/32	1-3/4	2-3/32
	1-1/4	2-1/8	2-29/32	2-1/8	2-29/32
	1-1/2	2-3/8	—	—	—

# FDO Cast Device Boxes Drilling and Tapping Information

## Malleable Iron, Aluminum

UNILETS™ for use with Threaded Rigid Conduit and IMC. All device boxes have ridge top construction.

CEC:  
Listed for Ordinary Locations

### Ordering Data

To determine the customized FDO box catalog number with drilled and tapped entries or hubs, the following information should be shown:

1. FDO box catalog number.
2. Sketch number of entry arrangement selected from illustrations below.
3. Entry symbols taken from the table right. Start from the left on the top of the Unilet and continue in rotation clockwise around its body. Where no entry is required, the symbol X should be inserted. The three various divisions of the catalog number should be separated by dashes.

### Ordering Example:

The box selected is a FD04 and the entry arrangement is sketch number 12. Entry A, B and C are to be 1/2" drilled and tapped for rigid conduit; D is to be a 1" hub and there is no entry at location E. The catalog number will be as follows FD04-12-111CX.

### Symbol Table

Hub Size (Inches)	Brazed Threaded Hub Symbol	Brazed Union Hub Symbol
Blank	X	X
1/2	1	A
3/4	2	B
1	3	C
1-1/4	4	D
1-1/2	5	E
2	6	F

### Single, Two, Three and Four-Gang — Front view and oriented as mounted

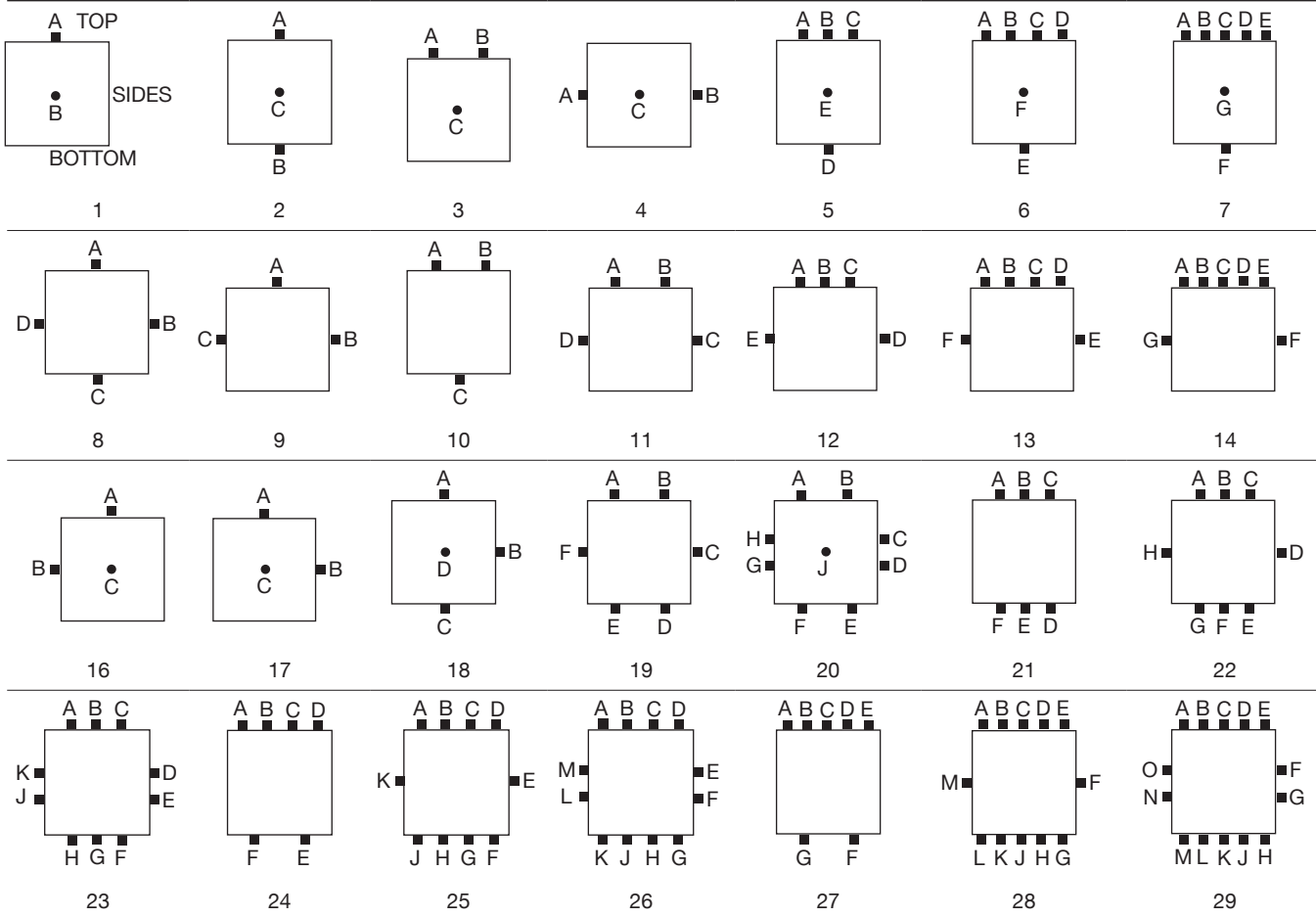

COMMERCIAL AND INDUSTRIAL FITTINGS: CAST DEVICE BOXES

APPLETON™