

Project	
Date	
Prepared by	
Model #	Area/Flood Mount Kit

FL4-SERIES ACCESSORIES

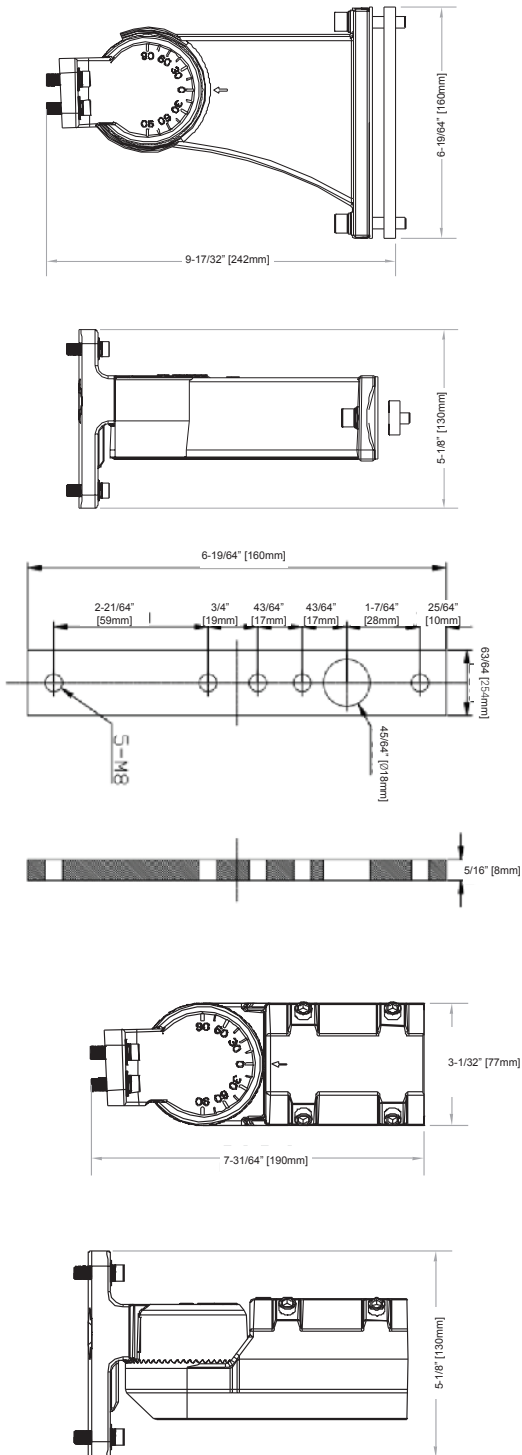

PRODUCT INFORMATION

Model #	FL-MA4
Description	Mounting Arm for FL4-Series Area/Flood Lights
Material	Aluminum Alloy
Compatible with	FL4-Series Area/Flood Lights
Dimensions	9-1/2" x 6-19/64" x 5-1/8" 242mm x 160mm x 130mm



PRODUCT INFORMATION

Model #	FL-SF4
Description	Slip Fitter for FL4-Series Area/Flood Lights
Material	Aluminum Alloy
Compatible with	FL4-Series Area/Flood Lights
Dimensions	8-15/64" x 5-1/8" x 3-1/32" 209mm x 130mm x 76.8mm Fits 2" - 2 3/8" OD tenon

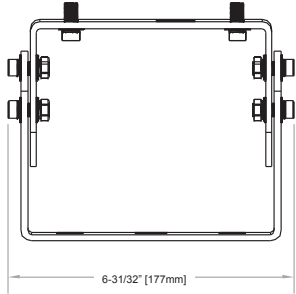
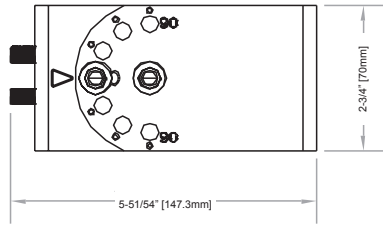

PRODUCT INFORMATION

Model #	FL-TR4
Description	Trunnion Mount for FL4-Series Area/Flood Lights
Material	Aluminum Alloy
Compatible with	FL4-Series Area/Flood Lights
Dimensions	5-51/64" x 6-31/32" x 2-3/4" 147.3mm x 177mm x 70mm

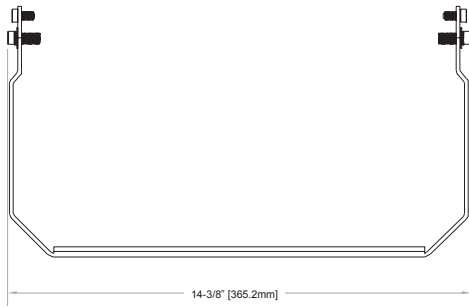
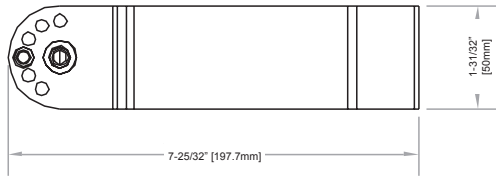

PRODUCT INFORMATION

Model #	FL-YK4
Description	Yoke Mount for FL4-Series Area/Flood Lights (for 80W to 300W models)
Material	Aluminum Alloy
Compatible with	FL4-Series Area/Flood Lights
Dimensions	7-25/32" x 14-3/8" x 1-31/32" 197.7mm x 365.2mm x 50mm

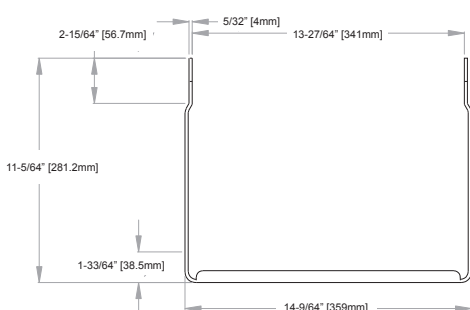
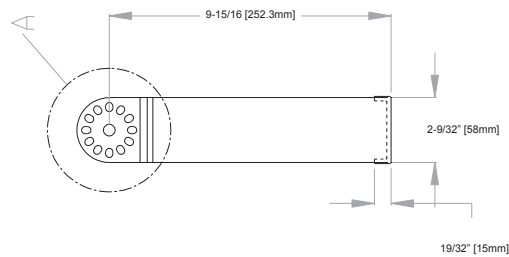

PRODUCT INFORMATION

Model #	FL-YK4504
Description	Yoke Mount for FL4-Series Area/Flood Lights (for 450W models only)
Material	Aluminum Alloy
Compatible with	FL4-Series Area/Flood Lights
Dimensions	14-9/64" x 9-15/16" x 2-9/32" 359mm x 252.3mm x 58mm

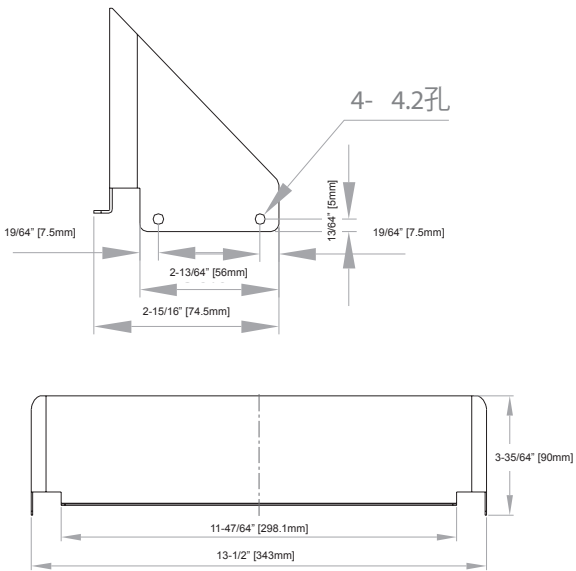

PRODUCT INFORMATION

Model #	FL-SHIELD14
Description	Glare Shield for FL4-Series Area/Flood Lights (80W/100/150W models only)
Material	Aluminum Alloy
Compatible with	FL4-Series Area/Flood Lights
Dimensions	13-1/2" x 3-35/ 4" x 2-15/16" 343mm x 90mm x 74.5mm

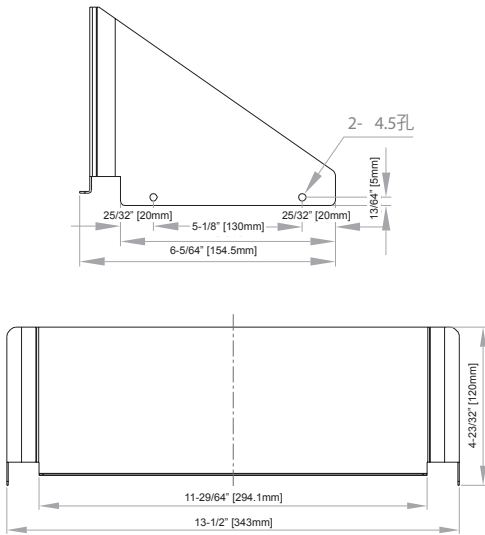

PRODUCT INFORMATION

Model #	FL-SHIELD24
Description	Glare Shield for FL4-Series Area/Flood Lights (200W/240/300W models only)
Material	Aluminum Alloy
Compatible with	FL4-Series Area/Flood Lights
Dimensions	13-1/2" x 6-5/64" x 4-23/32" 343mm x 154.5mm x 120mm

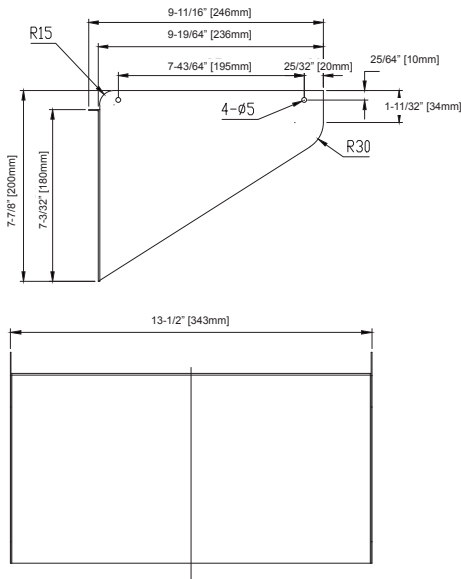

PRODUCT INFORMATION

Model #	FL-SHIELD34
Description	Glare Shield for FL4-Series Area/Flood Lights (450W models only)
Material	Aluminum Alloy
Compatible with	FL4-Series Area/Flood Lights
Dimensions	13-1/2" x 9-19/64" x 7-7/8" 343mm x 236mm x 200mm