



## Main

Range of Product	Modicon TM5
Product or Component Type	Safety dc discrete input module
Discrete input number	4
Discrete input voltage	24 V

## Complementary

Range Compatibility	PacDrive LMC motion controller
Product Compatibility	PacDrive LMC Eco PacDrive LMC Pro PacDrive LMC Pro 2
Discrete input voltage type	DC
Input voltage limits	20.4...28.8 V
Discrete input logic	Sink
Discrete input current	3.45 mA
Input impedance	7 kOhm
Color	Red
Voltage state 0 guaranteed	$\leq 5$ V
Voltage state 1 guaranteed	$\geq 15$ V
Input filtering	$\leq 500$ ms configurable by software $\leq 150$ ms hardware
Protection Type	Short-circuit protection Overload protection
Isolation	No insulation between channels 500 Vrms AC insulation between channel and bus
Maximum voltage drop	$< 0.6$ V at 100 mA
Maximum supply current for sensors	300 mA
Maximum power consumption in W	1.25 W internal 0.32 W bus
Local signalling	1 LED green power supply 1 LED red power supply 2 LEDs red safety status 4 LEDs green/red input status
Electrical connection	2 wires
Marking	CE
Safety level	SIL 3 IEC 61508 SIL 3 IEC 62061 PL = e EN 13849-1
Safety reliability data	MTTFd $> 100$ years PFD $< 1E-5$ PFH $< 1E-9$
Net Weight	0.06 lb(US) (0.025 kg)

The information provided in this documentation contains general descriptions and/or technical characteristics of the performance of the products contained herein. This documentation is not intended as a substitute for and is not to be used for determining suitability or reliability of these products for specific user applications. It is the duty of any such user or integrator to perform the appropriate and complete risk analysis, evaluation and testing of the products with respect to the relevant specific application or use thereof. Neither Schneider Electric Industries SAS nor any of its affiliates or subsidiaries shall be responsible or liable for misuse of the information contained herein.

## Environment

Standards	UL 508 IEC 62061 IEC 61508 EN 13849-1 IEC 61131-2 CSA C22.2 No 142
Product Certifications	GOST-R[RETURN]cULus[RETURN]CSA
Ambient air temperature for operation	14...122 °F (-10...50 °C) vertical installation) 14...131 °F (-10...55 °C) horizontal installation)
Ambient Air Temperature for Storage	-40...158 °F (-40...70 °C)
Relative Humidity	5...95 % without condensation
IP degree of protection	IP20EN 60529
Pollution degree	2 IEC 60664
Operating altitude	0...6561.68 ft (0...2000 m)
Storage altitude	0.00...9842.52 ft (0...3000 m)
Vibration resistance	1 gn 8.4...150 Hz DIN rail 3.5 mm 5...8.4 Hz DIN rail
Shock resistance	15 gn 11 ms
Electromagnetic compatibility	Electrostatic discharge immunity test, 4 kV on contact EN/IEC 61000-4-2 Electrostatic discharge immunity test, 8 kV in air EN/IEC 61000-4-2 Susceptibility to electromagnetic fields, 10 V/m 80...2000 MHz EN/IEC 61000-4-3 Electrical fast transient/burst immunity test, 1 kV I/O EN/IEC 61000-4-4 Electrical fast transient/burst immunity test, 1 kV shielded cable EN/IEC 61000-4-4 Electrical fast transient/burst immunity test, 2 kV power lines EN/IEC 61000-4-4 1.2/50 µs shock waves immunity test, 0.5 kV differential mode EN/IEC 61000-4-5 1.2/50 µs shock waves immunity test, 1 kV common mode EN/IEC 61000-4-5 Conducted RF disturbances EN/IEC 61000-4-6 Conducted and radiated emissions CISPR 11

## Ordering and shipping details

Category	18360-PACDRIVE3 SAFETY
Discount Schedule	PC52
GTIN	00785901946151
Returnability	No
Country of origin	AT

## Packing Units

Unit Type of Package 1	PCE
Number of Units in Package 1	1
Package 1 Height	1.18 in (3.000 cm)
Package 1 Width	2.36 in (6.000 cm)
Package 1 Length	4.13 in (10.500 cm)
Package 1 Weight	1.73 oz (49.000 g)
Unit Type of Package 2	S02
Number of Units in Package 2	50
Package 2 Height	5.91 in (15.000 cm)
Package 2 Width	11.81 in (30.000 cm)
Package 2 Length	15.75 in (40.000 cm)
Package 2 Weight	6.31 lb(US) (2.863 kg)

## Offer Sustainability

Sustainable offer status	Green Premium product
California proposition 65	WARNING: This product can expose you to chemicals including: Lead and lead compounds, which is known to the State of California to cause cancer and birth defects or other reproductive harm. For more information go to <a href="http://www.P65Warnings.ca.gov">www.P65Warnings.ca.gov</a>
REACH Regulation	<a href="#">REACH Declaration</a>
REACH free of SVHC	Yes
EU RoHS Directive	Pro-active compliance (Product out of EU RoHS legal scope) <a href="#">EU RoHS Declaration</a>
Toxic heavy metal free	Yes
Mercury free	Yes
China RoHS Regulation	<a href="#">China RoHS Declaration</a>
RoHS exemption information	<a href="#">Yes</a>
Environmental Disclosure	<a href="#">Product Environmental Profile</a>
Circularity Profile	<a href="#">End Of Life Information</a>
WEEE	The product must be disposed on European Union markets following specific waste collection and never end up in rubbish bins.
PVC free	Yes

## Contractual warranty

Warranty	18 months
----------	-----------

---

TM5 Slice

---

Dimensions

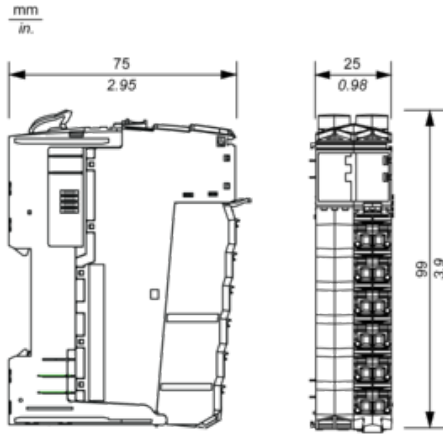

TM5 Safety System

Spacing Requirements

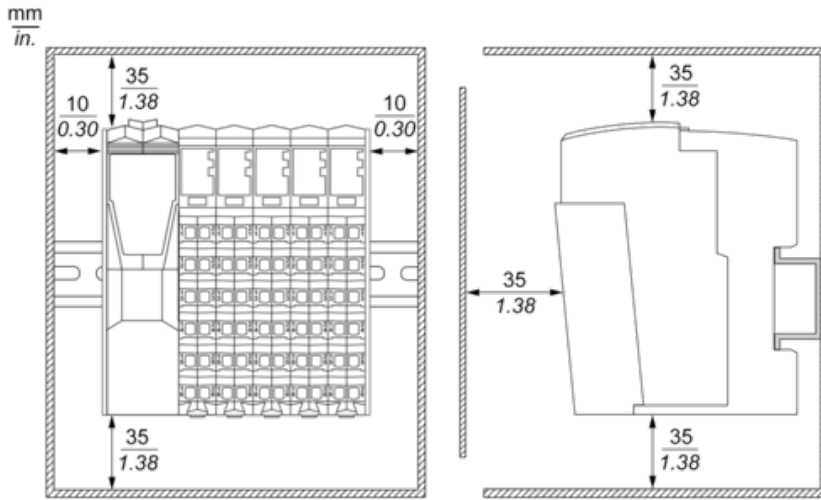



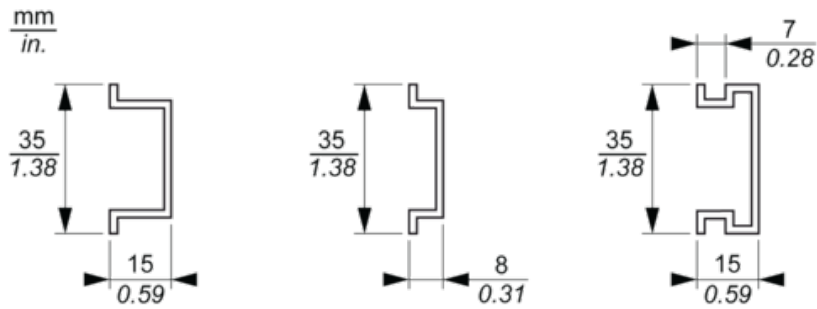

Mounting on a DIN Rail



TM5 System Wiring Recommendations

Wire Sizes to Use with the Removable Spring Terminal Blocks

mm in.				
mm <sup>2</sup>	0,08...2,5	0,25...2,5	0,25...1,5	2 x 0,25...2 x 0,75
AWG	28...14	24...14	24...16	2 x 24...2 x 18

Electronic Module 4DI 24 Vdc Sink 2 Wires

Wiring Diagram

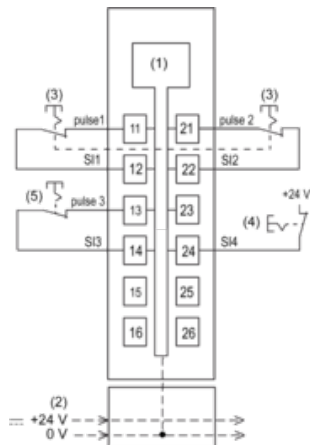

- (1) Internal electronics
- (2) 24 Vdc I/O power segment integrated into the bus bases
- (3) 2-wire sensor
- (4) single wire sensor, external power supply
- (5) single wire sensor, internal power supply