



MARCUS

Marcus Transformer LTD
 Phone: 1-800-267-7376
 Fax: 1-866-205-7526
 Email: Info@marcustransformer.com

TECHNICAL DATA SINGLE PHASE CONTROL TRANSFORMER

DESCRIPTION	
MODEL	MO25A
Type	Open
VA	25
Primary (Volts)	120 / 240
Secondary (Volts)	12 / 24
Input /Output Amps	0.21 , 0.10 / 2.08 , 1.04
Temperature Rise	80°C
Insulation Class	B (130°C)
Frequency	50 / 60Hz
Polarity	additive
Noise level	less than 40DB
Winding	Copper
Approvals	CE compliant UL listed CSA approved

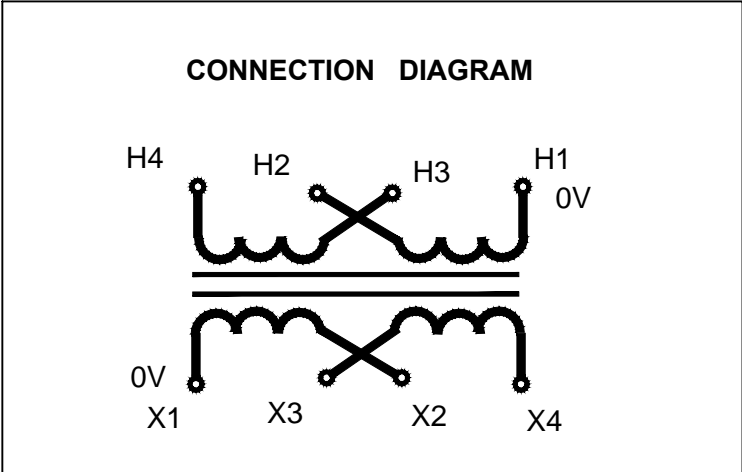

WIRING CONNECTION

PRIMARY :		
VOLTS	INTERCONNECT:	CONNECT LINES TO :
120	H1-H3 AND H2-H4	H1-H4
240	H2-H3	H1-H4
SECONDARY :		
VOLTS	INTERCONNECT:	CONNECT LINES TO :
12	X1-X3 AND X2-X4	X1-X4
24	X2-X3	X1-X4

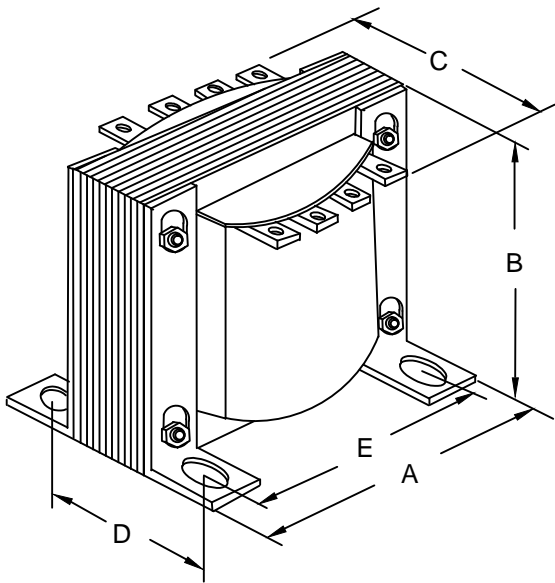

DIMENSIONS INCHES / MM

VA	A	B	C	D	E	MOUNTING HOLES INCHES / MM	SHIP WEIGHT LBS / KG
25	3.00 76.2	2.50 63.5	2.77 70.4	1.98 50.3	2.50 63.5	0.21 x 0.625 5.3 x 15.9	1.25 0.6

Notes: