

GV2L10

TeSys GV2 Manual Starter and Protector, magnetic circuit protector, rotary handle, 6.3 A, screw clamp terminals



Main

Range	TeSys
Product name	TeSys GV2
Device short name	GV2L
Device application	Motor
Poles description	3P
Network type	AC
Utilisation category	Category A IEC 60947-2 AC-3 IEC 60947-4-1
Network frequency	50/60 Hz IEC 60947-2
Breaking capacity	100 KA Icu 230/240 V AC 50/60 Hz IEC 60947-2 100 KA Icu 400/415 V AC 50/60 Hz IEC 60947-2 100 KA Icu 440 V AC 50/60 Hz IEC 60947-2 100 KA Icu 500 V AC 50/60 Hz IEC 60947-2 4 kA Icu 690 V AC 50/60 Hz IEC 60947-2
[Ics] rated service short-circuit breaking capacity	100 % 690 V AC 50/60 Hz IEC 60947-2 100 % 500 V AC 50/60 Hz IEC 60947-2 100 % 230/240 V AC 50/60 Hz IEC 60947-2 100 % 440 V AC 50/60 Hz IEC 60947-2 100 % 400/415 V AC 50/60 Hz IEC 60947-2
Trip unit technology	Magnetic
Magnetic tripping current	78 A

Complementary

Fixing mode	35 mm symmetrical DIN rail clipped Panel screwed with 2 x M4 screws)
Operating position	Any position
Motor power kW	2.2 KW 400/415 V AC 50/60 Hz 3 KW 500 V AC 50/60 Hz 4 kW 690 V AC 50/60 Hz
Control type	Rotary knob
[Ue] rated operational voltage	690 V AC 50/60 Hz IEC 60947-2
[Ui] rated insulation voltage	690 V AC 50/60 Hz IEC 60947-2
[Uimp] rated impulse withstand voltage	6 kV IEC 60947-2
Power dissipation per pole	1.8 W
Mechanical durability	100000 cycles
Electrical durability	100000 cycles AC-3 415 V
Maximum operating rate	40 cyc/h
Rated duty	Continuous IEC 60947-4-1
Connections - terminals	Screw clamp terminals 2 0.00...0.01 in ² (1...6 mm ²) solid Screw clamp terminals 2 0.00...0.01 in ² (1.5...6 mm ²) flexible without cable end Screw clamp terminals 2 0.00...0.01 in ² (1...4 mm ²) flexible with cable end
Tightening torque	15.05 lbf.in (1.7 N.m) screw clamp terminals
Mechanical robustness	Shocks 30 Gn IEC 60068-2-27 Vibrations 5 Gn, 5...150 Hz IEC 60068-2-6
Suitability for isolation	Yes IEC 60947-1
Height	3.50 in (89 mm)
Maximum Width	1.77 in (45 mm)
Depth	3.82 in (97 mm)
Net Weight	0.73 lb(US) (0.33 kg)

The information provided in this documentation contains general descriptions and/or technical characteristics of the performance of the products contained herein. This documentation is not intended as a substitute for and is not to be used for determining suitability or reliability of these products for specific user applications. It is the duty of any such user or integrator to perform the appropriate and complete risk analysis, evaluation and testing of the products with respect to the relevant specific application or use thereof. Neither Schneider Electric Industries SAS nor any of its affiliates or subsidiaries shall be responsible or liable for misuse of the information contained herein.

Environment

Standards	EN/IEC 60947-2 EN/IEC 60947-4-1 CSA C22.2 No 60947-4-1 UL 60947-4-1
Product certifications	IECEE CB Scheme UL CSA CCC EAC RINA LROS (Lloyds register of shipping) DNV-GL BV
Protective treatment	TH
IP degree of protection	IP20 IEC 60529
IK degree of protection	IK04
Ambient air temperature for operation	-4...140 °F (-20...60 °C)
Ambient air temperature for storage	-40...176 °F (-40...80 °C)
Fire resistance	1760 °F (960 °C) IEC 60695-2-1
Operating altitude	0...6561.68 ft (0...2000 m)



Ordering and shipping details

Category	22367 - MANUAL STR PROTECTOR - GV2
Discount Schedule	I11
GTIN	00785901076841
Nbr. of units in pkg.	1
Package weight(Lbs)	0.74 lb(US) (0.34 kg)
Returnability	No
Country of origin	FR

Packing Units

Unit Type of Package 1	PCE
Package 1 Height	1.81 in (4.6 cm)
Package 1 width	3.66 in (9.3 cm)
Package 1 Length	3.94 in (10 cm)
Unit Type of Package 2	S02
Number of Units in Package 2	20
Package 2 Weight	14.80 lb(US) (6.714 kg)
Package 2 Height	5.91 in (15 cm)
Package 2 width	11.81 in (30 cm)
Package 2 Length	15.75 in (40 cm)
Unit Type of Package 3	P06
Number of Units in Package 3	320
Package 3 Weight	269.71 lb(US) (122.34 kg)
Package 3 Height	31.50 in (80 cm)
Package 3 width	31.50 in (80 cm)
Package 3 Length	23.62 in (60 cm)

Offer Sustainability

Sustainable offer status	Green Premium product
California proposition 65	WARNING: This product can expose you to chemicals including: Antimony oxide & Antimony trioxide, which is known to the State of California to cause cancer. For more information go to www.P65Warnings.ca.gov
REACH Regulation	 REACH Declaration
EU RoHS Directive	Compliant  EU RoHS Declaration
Mercury free	Yes

RoHS exemption information	Yes
China RoHS Regulation	China RoHS Declaration
Environmental Disclosure	Product Environmental Profile
WEEE	The product must be disposed on European Union markets following specific waste collection and never end up in rubbish bins.

Contractual warranty

Warranty	18 months
----------	-----------

Tripping Curves for GV2L or LE Combined with Thermal Overload Relay LRD or LR2K

Average Operating Times at 20 °C Related to Multiples of the Setting Current

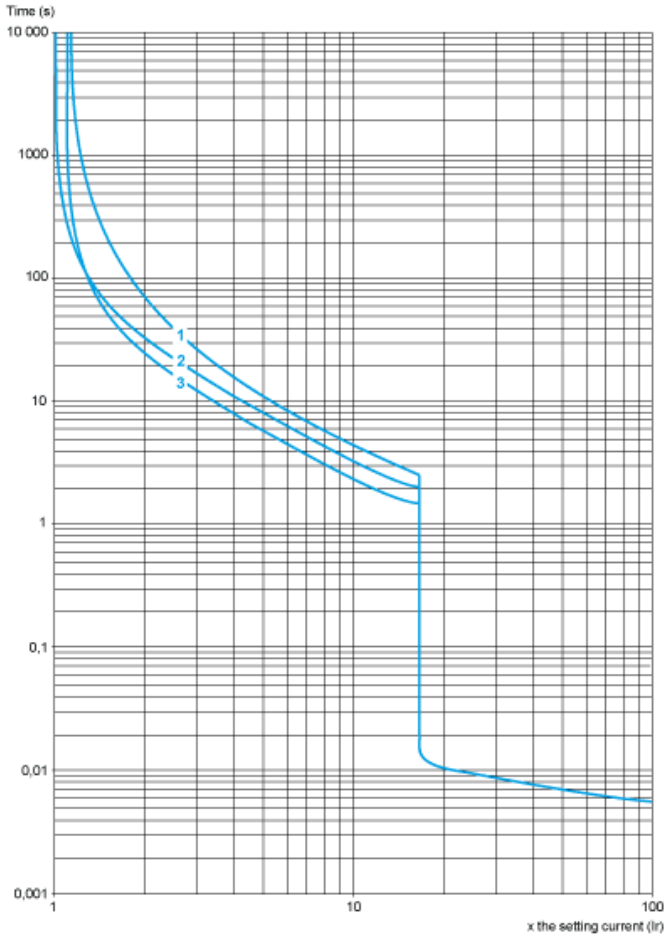

- 1 3 poles from cold state
- 2 2 poles from cold state
- 3 3 poles from hot state

Current Limitation on Short-Circuit for GV2L and GV2LE Only (3-Phase 400/415 V)

Dynamic Stress

$I_{peak} = f(\text{prospective } I_{sc}) \text{ at } 1.05 U_e = 435 \text{ V}$

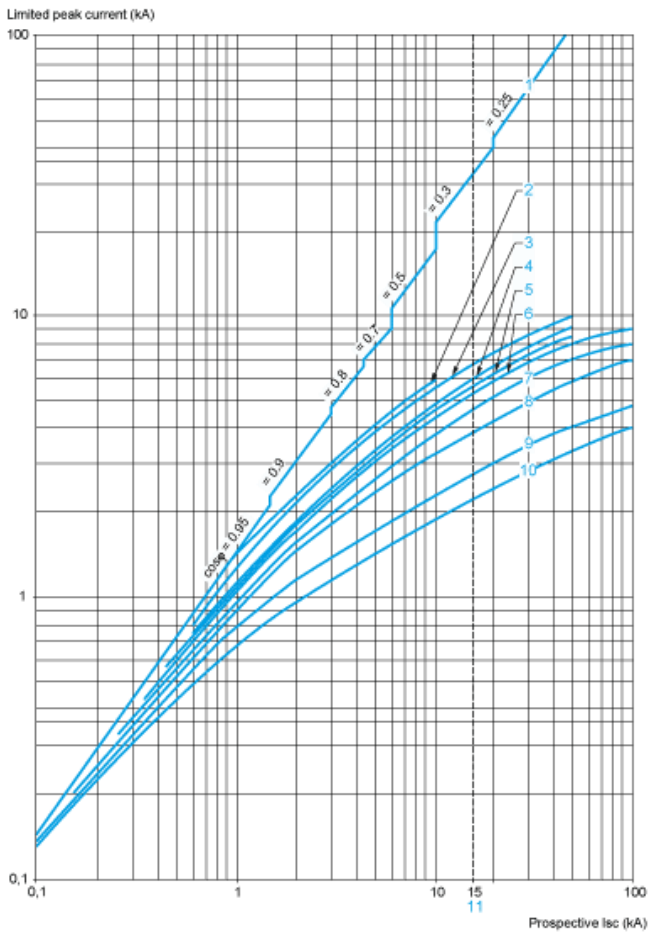

- 1 Maximum peak current
- 2 32 A
- 3 25 A
- 4 18 A
- 5 14 A
- 6 10 A
- 7 6.3 A
- 8 4 A
- 9 2.5 A
- 10 1.6 A
- 11 Limit of rated ultimate breaking capacity on short-circuit of GV2LE (14, 18, 23, and 25 A ratings).

Current Limitation on Short-Circuit for GV2L and GV2LE + Thermal Overload Relay LRD or LR2K (3-Phase 400/415 V)

Dynamic Stress

$I_{peak} = f(\text{prospective Isc}) \text{ at } 1.05 U_e = 435 \text{ V}$

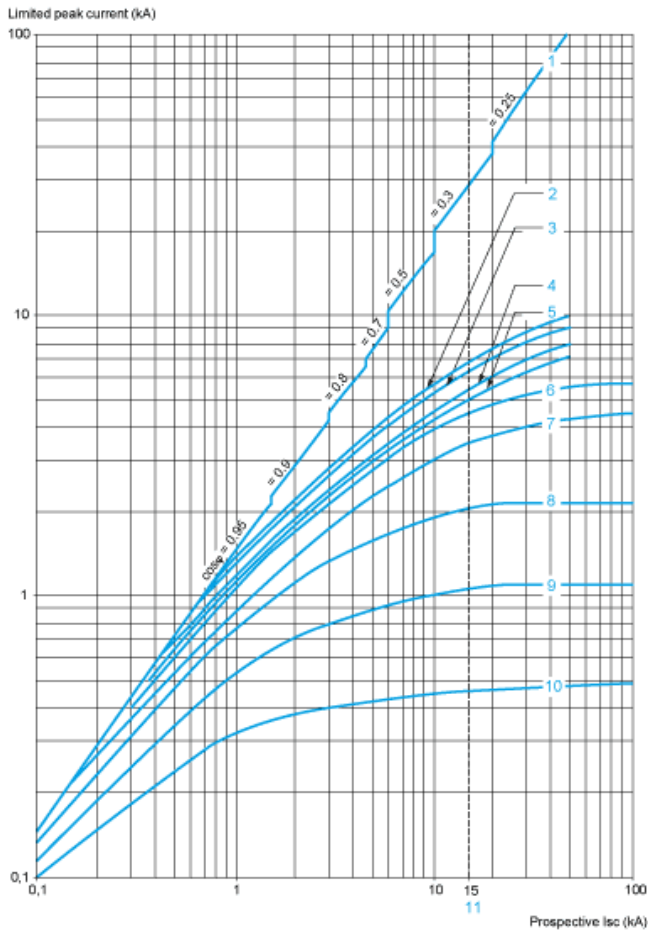

- 1 Maximum peak current
- 2 32 A
- 3 25 A
- 4 18 A
- 5 14 A
- 6 10 A
- 7 6.3 A
- 8 4 A
- 9 2.5 A
- 10 1.6 A
- 11 Limit of rated ultimate breaking capacity on short-circuit of GV2LE (14, 18, 23, and 25 A ratings).

Thermal Limit on Short-Circuit for GV2L Only

Thermal Limit in kA^2s in the Magnetic Operating Zone

Sum of $I^2dt = f$ (prospective Isc) at $1.05 U_e = 435 V$

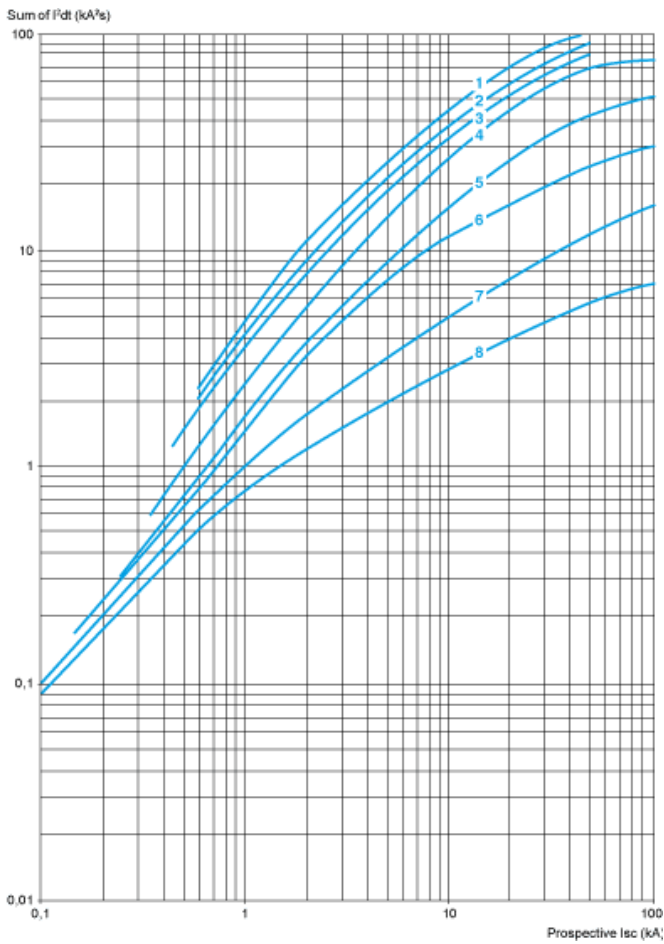

- 1 25 A and 32 A
- 2 18 A
- 3 14 A
- 4 10 A
- 5 6.3 A
- 6 4 A
- 7 2.5 A
- 8 1.6 A

Thermal Limit on Short-Circuit for GV2L and GV2LE + Thermal Overload Relay LRD or LR2K

Thermal Limit in kA^2s in the Magnetic Operating Zone

Sum of $I^2dt = f(\text{prospective Isc})$ at $1.05 U_e = 435 \text{ V}$

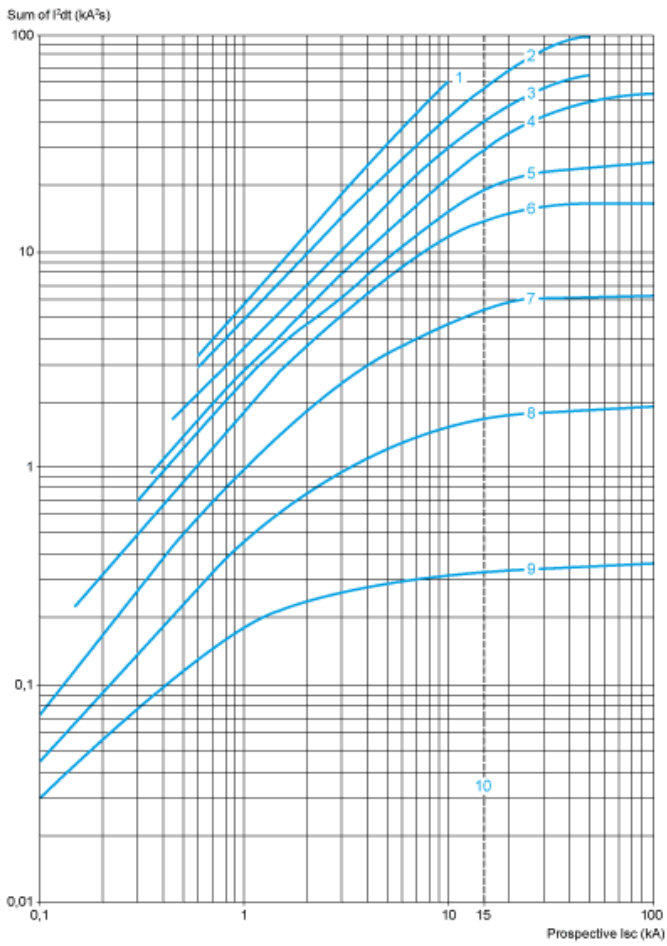

- 1 32 A (GV2LE32)
- 2 25 A and 32 A (GV2L32)
- 3 18 A
- 4 14 A
- 5 10 A
- 6 6.3 A
- 7 4 A
- 8 2.5 A
- 9 1.6 A
- 10 Limit of rated ultimate breaking capacity on short-circuit of GV2 LE (14, 18, 23, and 25 A ratings).

GV2L

Dimensions

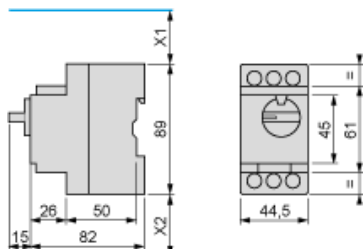

X1 Electrical clearance = 40 mm for $U_e \leq 415$ V, or 80 mm for $U_e = 440$ V, or 120 mm for $U_e = 500$ and 690 V.

X2 = 40 mm.

GVAD, AM, AN, AU, AS

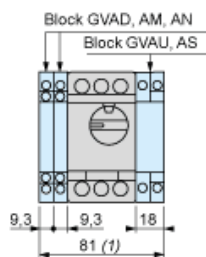

1 Maximum
GV2AK00

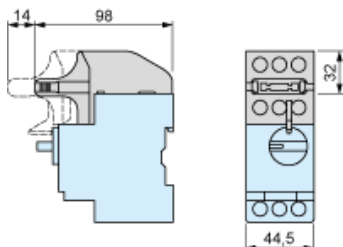

Mounting

On rail AM1 DE200, AM1 ED200 (35 x 15)



Panel mounted

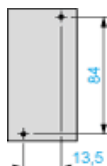

On pre-slotted mounting plate AM1 PA

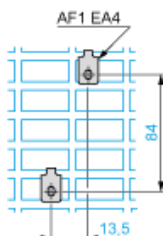

Adapter Plate GK2AF01

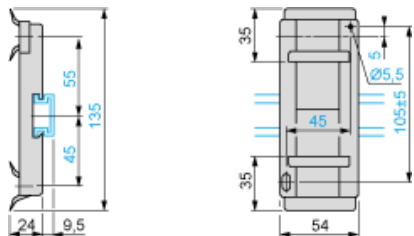

7.5 mm Height Compensation Plate GV1F03

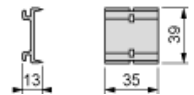

Mounting

Mounting of External Operator GV2APN01, GV2APN02 or GV2APN04 for Motor Circuit Breakers GV2L

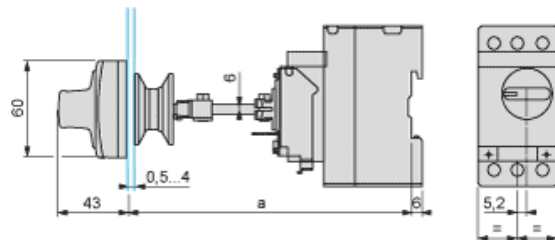

Door cut-out

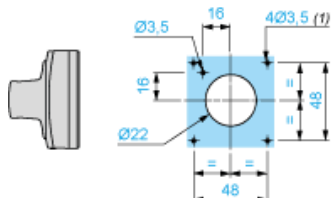

(1) For IP65 only.

Mounting of External Operator GVAPH02 for Motor Circuit Breakers GV2L

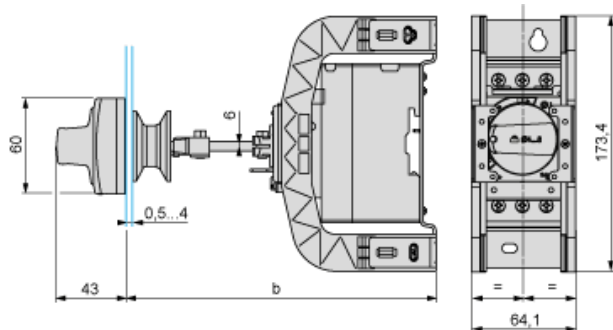

	b	
	Minimum	Maximum
GV2 APN... + GV APH02	151	250
GV2 APN... + GV APH02 + GV APK11	250	445

Door cut-out

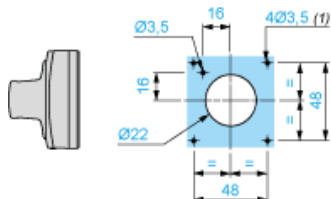

(1) For IP65 only.

GV2L and GV2LE

Sets of busbars GV2G445, GV2G454, GV2G472, with terminal block GV2G05

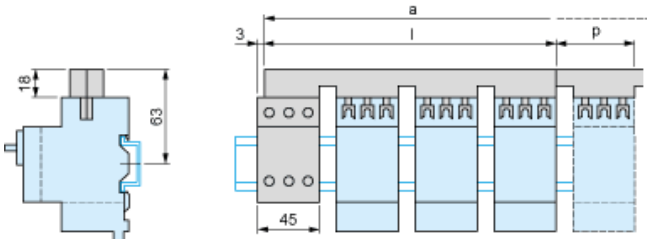

	l	p
GV2G445 (4 x 45 mm)	179	45
GV2G454 (4 x 54 mm)	206	54
GV2G472 (4 x 72 mm)	260	72

Number of tap-offs	a			
	5	6	7	8
GV2G445	224	269	314	359
GV2G454	260	314	368	422
GV2G472	332	404	476	548

Sets of Busbars for GV2L and GV2LE

Sets of busbars GV2G... with terminal block GV1G09

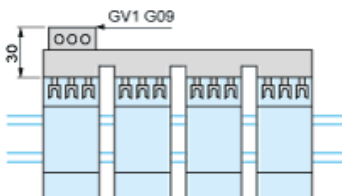

Sets of busbars GV2G245, GV2G254, GV2GR272

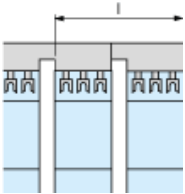

	l
GV2G245 (2 x 45 mm)	89
GV2G254 (2 x 54 mm)	98
GV2G272 (2 x 72 mm)	116

Set of busbars GV2G554

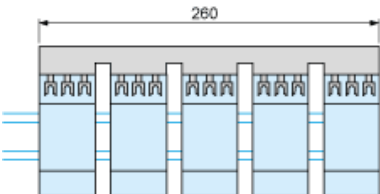

Sets of busbars GV2G345 and GV2G354

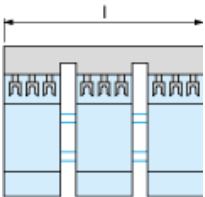

	l
GV2G345 (3 x 45 mm)	134
GV2G354 (3 x 54 mm)	152

GV2L••

